

T 15S. R 9E.

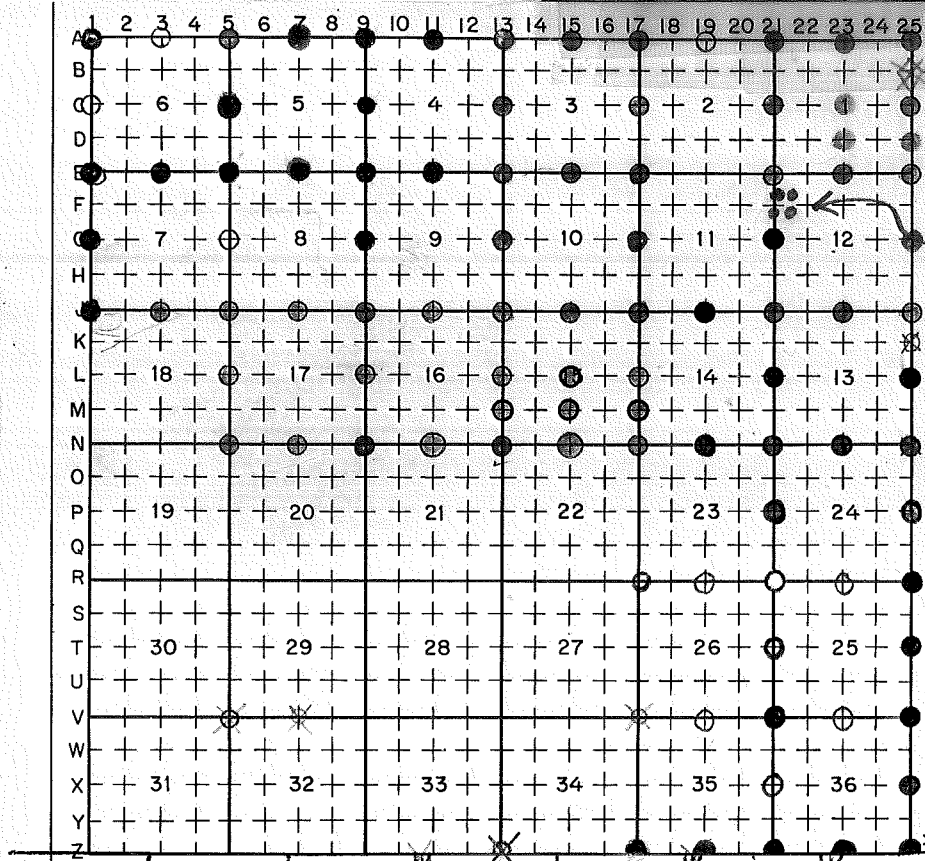

LEGEND

○ = Corner having information on form 5680-2 in this file.

*Legend Confirms To Reporting Form 1/29
see Back of section for BOY adj.*

FILING INSTRUCTION

File 5680-2 card record by letter and number coordinates behind the file guide for the township in which it falls.

File the 5680-2 card record by letter and then by number i.e., all A cards first, then B cards etc.

The first card behind the file guide (if data have been obtained and recorded) will be card A-1 for N.W. Township Corner, then card A-2 for 1/16 corner then card A-3 for 1/4 corner etc.

*T15S
T16S 3RD STD. 1/4 S,*

4 25 01
CORNER RECORD FILE GUIDE (Rectangular Surveys)
1 6 5 4 3 2 25 01
GPO 892-953

Index File No. 0125 CORNER RECORD (SEARCH) Contract or Survey No. A-01
(Ref. FSM 7151.4)
T 15 S. R. 9 E. R.D. SISTERS County DESCHUTES NW Cor. of
Merid. Willamette N.F. Deschutes State Oregon Section 6

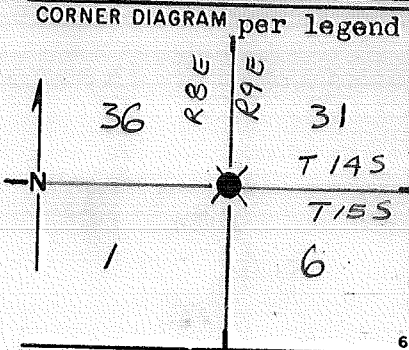

DESCRIBE CORNER MONUMENT FOUND
S F N F

STONE OF APPROX SIZE SEVERAL FEET AWAY FROM BT DISTANCE LOCATION, NO MARKS

DESCRIBE BEARING TREES OR OTHER OFFICIAL ACCESSORIES FOUND

ORG. 26 1/2" FIR 10' SNAG SCRIBED T14SR9E526
5 1/2" FIR N20°W, 311ks. (DEAD) SC80 T14SR9E526 BT
7" FIR S24°W, 551ks HEALED OVER

PHOTO IDENTIFICATION DATA

Photo No. _____
Filed At. _____
Object Ident. _____
Ident. By _____
Signature _____

1ft. 18" DIA. STUMP W/ BT TAG N45 1/2°W 41 1/21ks. NO SC86
12 1/2" FIR N14 1/2°E - HEALED OVER

DESCRIBE CORNER LOCATION RELATIVE TO NEAR-BY FEATURES, ALSO HOW TO REACH CORNER

BT'S. APPEAR SET BY LIKE COR. A-05, A-13, ETC.
COR. IS 110' N. OF STATE 242
ATTN SIGNS & LOCATION TAGS POSTED ON 242 & DIRT ROAD 95' N. OF COR.

CORNER LEGEND:
FS or Unverified
Contr. Other
 Searched For/Not Found
 Evidence Found/Accept.
 Permanent Mon. Set/Fd.

Searched By: M. HEATH Title ST Division CS Headquarters SO Date 8-11-83

CORNER RECORD (PERPETUATION)

MONUMENT: DESCRIBE NEW MONUMENT SET, OR WORK DONE TO PRESERVE EXISTING MONUMENT

6/86 - WALT MILLER (PLS - 2111) Set from evidence
a 2 1/2" x 30" BCSP Rising 6" in rock collar.

MONUMENT STAMPED

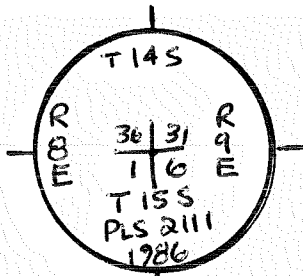

9

ACCESSORIES : DESCRIBE NEW BT's WITNESS OBJECTS ETC. ESTABLISHED, OR WORK DONE TO PRESERVE EXISTING EVIDENCE

- 1) 6/86: A 12" white fir brs N 75° 50' W @ 43⁰⁰ FT to a 60 d nail, w/brass washer (LS 2111) in the NNE base, marked T14SR0ES36BT
- 2) A 10" W.F., brs S 87° 08' E @ 24⁵⁰ FT, to a 60 d nail w/brass washer (LS 2111) in the N base MARKED T15SR9ES6BT

10

Work Done By Walt Miller Title PLS Date 6/86 State Registration No. 2111
or Agency
Plat or Certified Cor. Record Prepared? Yes No Filed At: Deschutes Co. Surveyor's Office Date 7/23/86

11

History of Surveys, G.L.O., etc. STONE 14" x 12" x 7"
PINE 8 IN. N 58 1/2° W 31 lks. (20⁵)

BC By BLM ?
See plat No 000705

Index File No. T. 15 S., R. 9 E., W.M. Contract or Surv. No. Cor. A-01

12

13

LAND CORNER RECORD

(Rectangular)

Oregon

5680-2

A-3

Dist. Sisters

1. T 15S R9E No. A-3 Cor. 1/4 Mer Will State N. F. Deschutes

2. Corner Status

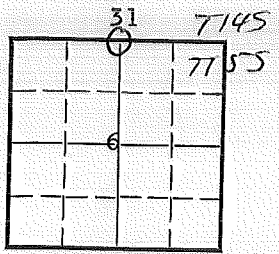

3. Original Description Vol. Page Where Recorded

4. Description of Corners:

SFNF

5. Investigation Notes: See T14S, R9E, Z-3
No evidence.

SFNF

7. Photo Identification

Photo No. _____

Ident. By: _____

8. Plane Coordinate Position Data

State _____ Zone _____

X _____

Y _____

Estab. By _____

Field Book No. _____

Where Filed _____

9. Evaluation

Authentic _____

Needs Verif. _____ Monument _____

Re-estab. _____ Survey _____

and Status _____

S. CHAMBERLAIN 8-17-83

6. Signed O. Inuzualp Title Hwy. Eng. Date 2-12-63

PERPETUATION RECORD

10. Monument:

11. Accessories

		Field Book _____	Page _____
12. Set By _____ Title _____		13. Recorded By _____	Volume _____ Page _____
License _____	Agency _____	(Agency)	
Date _____		(Date) _____ (City) _____	(County) _____ (State) _____

14. Remarks:

Index

File No. 5/51

CORNER RECORD (SEARCH) Contract or

(Ref. FSM 7151.4)

Survey No. 4-1

Cor. No. A 5

T. 15 S. R. 9 E. R.D. SISTERS

County Deschutes

NW Cor. of

Merid. Willamette

N.F. Deschutes

State Oregon

Section 5

CORNER DIAGRAM per legend

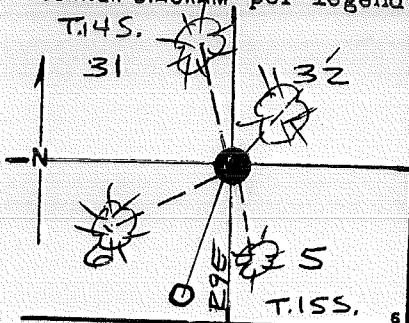

DESCRIBE CORNER MONUMENT FOUND

Fd. 3/4" U.S. B.L.M. B.C'd, 2 1/2" I.P., ESG 0.3'

DESCRIBE BEARING TREES OR OTHER OFFICIAL ACCESSORIES FOUND

10" P.PINE - N12°W, 29.8'

9" P.PINE - N46°E, 5.5'

9" P.PINE - S56°W, 28.6'

7" P.PINE - S8°E, 9.0'

48' STUMP - S9°W, 33' (ORIGINAL)

DESCRIBE CORNER LOCATION RELATIVE TO NEAR-BY FEATURES, ALSO HOW TO REACH CORNER

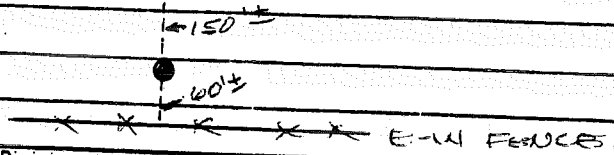
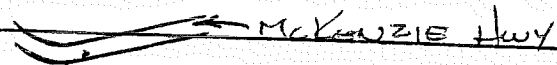

PHOTO IDENTIFICATION DATA

Photo No. _____
 Filed At. _____
 Object Ident. _____
 Ident. By _____
 Signature _____

CORNER LEGEND:

- | | | |
|--------------|------------------|------------------------|
| FS or Contr. | Unverified Other | |
| ○ | ◇ | Searched For/Not Found |
| ⊗ | ⊗ | Evidence Found/Accept. |
| ● | ◆ | Permanent Mon. Set/Id. |

Searched By: FRED ART Title PLS

Division

Headquarters

Date 5/85

CORNER RECORD (PERPETUATION)

MONUMENT. DESCRIBE NEW MONUMENT SET, OR WORK DONE TO PRESERVE EXISTING MONUMENT

NONE RECD

MONUMENT STAMPED

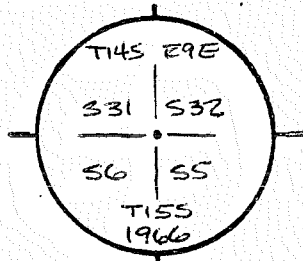

ACCESSORIES DESCRIBE NEW BT'S WITNESS OBJECTS ETC. ESTABLISHED, OR WORK DONE TO PRESERVE EXISTING EVIDENCE

NONE RECD

Work Done By FRED AST Title PLS Date 5/85 State Registration No. 1938
or Agency

Plat or Cor Record Prepared? Yes No Filed At DESCH Co. Surveyor's Office Date 6/85

History of Surveys, G.L.O., etc.
1870 - G.L.O. - J. McCune
1966 - USBLM REMONUMENTATION - J.E. JERLEY

Index File No. 5-51 T.15 S., R. 9 E., W.M. Contract or Surv. No. 4-1 Cor. A 5

Index

File No. 7/51

CORNER RECORD (SEARCH) Contract or

(Ref. FSM 7151.4)

Survey No. 4-1

Cor. No. A/7

T 15 S. R. 9 E.

R.D. Sisters

County Deschutes

N/4 Cor. of

Merid. Willamette

N.F. Deschutes

State Oregon

Section 5

CORNER DIAGRAM per legend

DESCRIBE CORNER MONUMENT FOUND

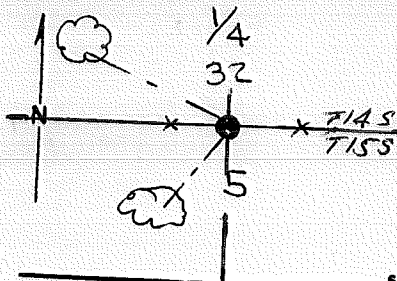

Fnd. orig. stone, firmly set & RSG 0.3'
in an E-W Fence line

DESCRIBE BEARING TREES OR OTHER OFFICIAL ACCESSORIES FOUND

PHOTO IDENTIFICATION DATA

Photo No. _____

Filed At. _____

Object Ident. _____

Ident. By _____

Signature _____

DESCRIBE CORNER LOCATION RELATIVE TO NEAR-BY FEATURES, ALSO HOW TO REACH CORNER

CORNER LEGEND:

- FS or Contr. Unverified
- Other Searched For/Not Found
- Evidence Found/Accept.
- Permanent Mon. Set/Yd.

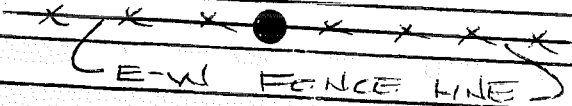

Searched By: FRED AST

Title PLS

Division _____

Headquarters _____

Date 5/25

MONUMENT. DESCRIBE NEW MONUMENT SET, OR WORK DONE TO PRESERVE EXISTING MONUMENT

Set 2 1/2" x 30" b.c.d. 1.p. Rsg. 0.5'
in a stone mound. Buried orig. stone
along side NEW MONUMENT.

MONUMENT STAMPE

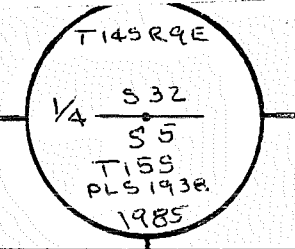

ACCESSORIES DESCRIBE NEW BT'S WITNESS OBJECTS ETC. ESTABLISHED, OR WORK DONE TO PRESERVE EXISTING EVIDENCE

Scribed B.T.S.:

9" P. Pine N 60° W 13⁰³'

T145 R9E S32 BT

8" P. Pine S 43° W 8⁰⁰'

T155 R9E S5 BT

A GOD SPIKE w/ "LS 1938" WASTER DRIVEN INTO SIDE CENTER BASE 10

Work Done By Fred Ast Title PLS Date 5/85 State Registration No. 1938
or Agency

PLS Certified For Record Prepared? Yes No Filed At Desch Co. Surveyor's Office Date 6/85 11

History of Surveys, G.L.O., etc. 1870 GLO BY J. McCLUNG

Index File No. 751 T. 15 S., R. 9 E., W.M. Contract or Surv. No. 4-1 Cor. A/7 13

Index

File No. 9-51

CORNER RECORD (SEARCH) Contract or

(Ref. FSM 7151.4)

Survey No. 4-1

Cor.

No. A 9

T 15 S. R. 9 E. R.D. SISTERS

County DESCHUTES

N.E

Cor. of

Merid. Willamette

N.F. Deschutes

State Oregon

Section 5

CORNER DIAGRAM, per Legend

DESCRIBE CORNER MONUMENT FOUND

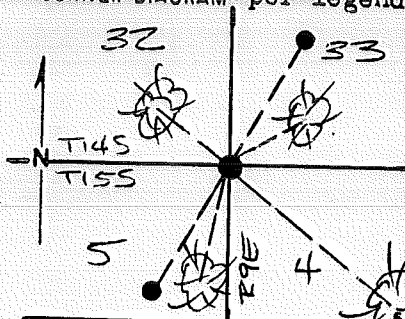

SFNF

DESCRIBE BEARING TREES OR OTHER OFFICIAL ACCESSORIES FOUND

SFNF

PHOTO IDENTIFICATION DATA

Photo No. _____

Filed At. _____

Object Ident. _____

Ident. By _____

Signature _____

DESCRIBE CORNER LOCATION RELATIVE TO NEAR-BY FEATURES, ALSO HOW TO REACH CORNER

3' SOUTH OF THE N. EDGE OF THE
MCKENZIE HIGHWAY

CORNER LEGEND:

FS or Unverified
Constr. Other

○ ◇ Searched For/Not Found

⊗ ⊗ Evidence Found/Accept.

● ◆ Permanent Mon. Set/To.

Searched By: FRED AST Title PLS

Division _____

Headquarters _____

Date 5/85

CORNER RECORD (PERPETUATION)

MONUMENT. DESCRIBE NEW MONUMENT SET, OR WORK DONE TO PRESERVE EXISTING MONUMENT

SET $5/8"$ x $30"$ IRON ROD W/ YELLOW PLASTIC

CAP. MARKED AS SHOWN

FLUSH WITH ROAD SURFACE.

ALSO
* SET REFERENCE MONUMENTS AS SHOWN BELOW

ACCESSORIES DESCRIBE NEW BT'S WITNESS OBJECTS ETC. ESTABLISHED, OR WORK DONE TO PRESERVE EXISTING EVIDENCE

SCRIBED B.T.'S: 7" P. PINE - $N37^{\circ}E$, 21.10'

606 SPIKES W/ 7" P. PINE - $S46^{\circ}E$, 57.35'

"PLS 1938" ALUM. 5" P. PINE - $S11^{\circ}W$, 40.47'

WAS LOTS DRIVEN 6" P. PINE - $N49\frac{1}{4}^{\circ}W$, 29.59'

INTO SIDE CENTER BASE

MONUMENT STAMPED

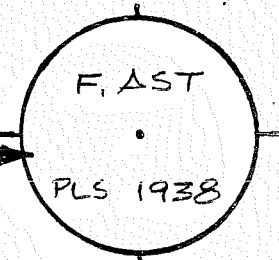

REF. MON'S - $2\frac{1}{2}"$ x $30"$ B.C.D. I.P.

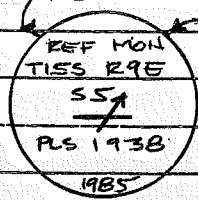

BEARS

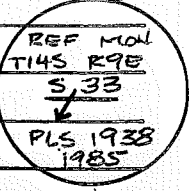

BEARS

$N25\frac{1}{2}^{\circ}E$, 42.00'

MON'S EISE 0.4' ABOVE GROUND

Work Done By FRED AST Title P.L.S. Date 5/85 State Registration No. 1938
or Agency

Plan of Certified Cor Record Prepared Yes No Filed At Desch Co. Surveyor's Office Date 6/85

History of Surveys, G.L.O., etc. 1870 G.L.O. ~ J. McCLEUNG

Index File No. 9-51 T. 15 S., R. 9 E., W.M.

Contract or Surv. No 4-1

Cor. A 9

Index

File No. 11151

CORNER RECORD (SEARCH) Contract or

(Ref. FSM 7151.4)

Survey No. 4-1

Cor. No. A/11

T 15 S. R. 9 E. R.D. Sisters

County Deschutes

Section 4 Cor. of

Merid. Willamette

N.F. Deschutes State Oregon

CORNER DIAGRAM per Legend

DESCRIBE CORNER MONUMENT FOUND

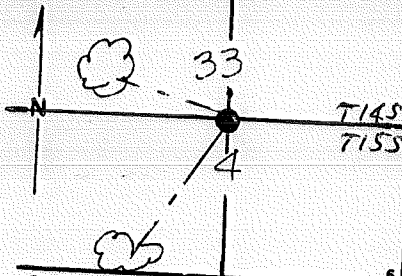

NONE

DESCRIBE BEARING TREES OR OTHER OFFICIAL ACCESSORIES FOUND

NONE

PHOTO IDENTIFICATION DATA

Photo No. _____
 Filed At. _____
 Object Ident. _____
 Ident. By _____

DESCRIBE CORNER LOCATION RELATIVE TO NEAR-BY FEATURES, ALSO HOW TO REACH CORNER

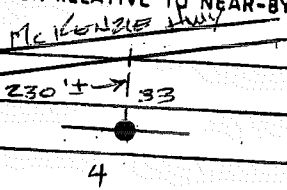

CORNER LEGEND:

- FS or Unverified
- Constr. Other
- ◊ Searched For/Not Found
- ⊗ ⊗ Evidence Found/Accept.
- ◆ Permanent Mon. Set/Yd.

Searched By FRED AST

Title PLS

Division

Headquarters

Date 5/85

MONUMENT DESCRIBE NEW MONUMENT SET, OR WORK DONE TO PRESERVE EXISTING MONUMENT

Set 2 1/2" x 30" b.c.d. 1.P. R56 0.3'
in stone mound
'single proportioned'

MONUMENT STAMPE

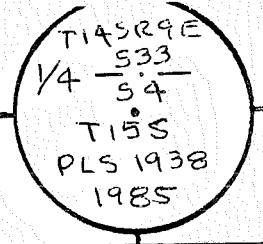

ACCESSORIES DESCRIBE NEW BT'S WITNESS OBJECTS ETC. ESTABLISHED, OR WORK DONE TO PRESERVE EXISTING EVIDENCE

Scribed B.T's:

10" p. pine - N85°W @ 64°2'

T14S E9E 1/4 S33 BT

10" p. pine - S35 1/2°W @ 85°5'

T15S E9E 1/4 S.4 BT

60d SPIRES w/ "PLS 1938" MASTERS WERE DRILLED INTO SIDE CENTER BASE 10

Work Done By Fred Ast Title PLS Date 5/85 State Registration No. 1938
or Agency

Flat Certified For Record Prepared? Yes No Filed At Detroit Co. Surveyor's Office Date 6/85

History of Surveys, G.L.O., etc.
1870 - GLO BY J. McCLUNG

Index File No. 11/51 T.15 S., R. 9 E., W.M.

Contract or Surv. No 4-1

Cor. A/11

Index File No. 13/51

CORNER RECORD (SEARCH) Contract or (Ref. FSM 7151.4) Survey No. 4-1

Cor. No. A/13

T 15 S. R. 9 E.

R.D. Sisters

County Deschutes

Merid. Willamette

N.F. Deschutes

State Oregon

Section 4

CORNER DIAGRAM per legend

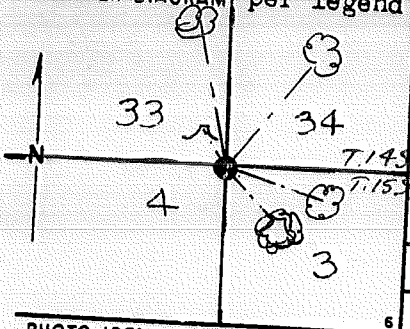

DESCRIBE CORNER MONUMENT FOUND

End 3 1/4" U.S. B.L.M. b.c. on a 2 1/2" l.p. Rsg. o.s.

DESCRIBE BEARING TREES OR OTHER OFFICIAL ACCESSORIES FOUND

- END B.T.'S: 23" P.Pine - N10 1/2° W @ 84 LKS
- 20" P.Pine - N30° E @ 78 1/2 LKS
- 16" P.Pine - N72° E @ 33'-"
- 21" P.Pine - S44° E @ 47 LKS
- 17" P.Pine stump - N31° W @ 112' (orig)

PHOTO IDENTIFICATION DATA

Photo No. _____
 Filed At. _____
 Object Ident. _____
 Ident. By _____
 Signature _____

CORNER LEGEND:

- FS or Contr. Unverified Other
- ◊ Searched For/Not Found
 - ⊗ ⊗ Evidence Found/Accept.
 - ◆ Permanent Mon. Set/Yd.

DESCRIBE CORNER LOCATION RELATIVE TO NEAR-BY FEATURES, ALSO HOW TO REACH CORNER

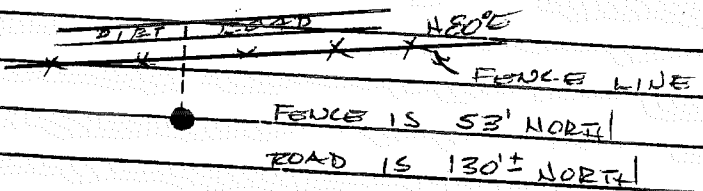

Searched By: FRED AST

Title PLS

Division

Headquarters

Date 5/85

DESCRIBE NEW MONUMENT SET, OR WORK DONE TO PRESERVE EXISTING MONUMENT

NONE RECD

MONUMENT STAMP

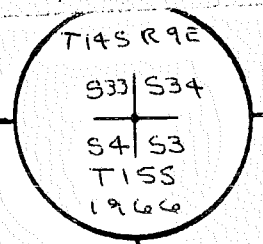

ACCESSORIES DESCRIBE NEW BT'S WITNESS OBJECTS ETC. ESTABLISHED, OR WORK DONE TO PRESERVE EXISTING EVIDENCE

NONE RECD

Work Done By Fred Ast Title PLS Date 5/85 State Registration No. 1938 or Agency

Established Cor Record Prepared? Yes No Filed At Desa Co. Surveyor's Office Date 6/85

History of Surveys, G.L.O., etc. 1870 - GLO - J. McClung

Index File No. 13/15 T. 15 S., R. 9 E., W.M. Contract or Surv. No 4-1 Cor. A/13

LAND CORNER RECORD

5680-2

A-15
Dist. Sisters

1. T. 15S R. 9E No. A-15 Cor. 1/4 Mer. Will State Oregon (Rectangular) N. F. Deschutes

2. Corner Status

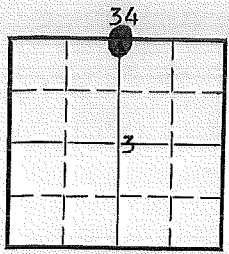

3. Original Description _____ Vol. _____ Page _____ Where Recorded _____

4. Description of Corners: _____

5. Investigation Notes: See T14S, R9E, Z-15

BE

7. Photo Identification

Photo No. _____

Ident. By: _____

8. Plane Coordinate Position Data

State _____ Zone _____

X _____

Y _____

Estab. By _____

Field Book No. _____

Where Filed _____

9. Evaluation

Authentic _____

Needs Verif. _____ Monument _____

Re-estab. _____ Survey _____

Land Status _____

6. Signed O. Thurgood Title _____ Hwy. Eng. _____ Date 2-12-63

PERPETUATION RECORD

10. Monument:

11. Accessories

		Field Book _____	Page _____
12. Set By _____	Title _____	13. Recorded By _____	Volume _____
License _____	Agency _____	(Agency)	Page _____
Date _____		(Date) _____	(City) _____
		(County) _____	(State) _____

14. Remarks:

LAND CORNER RECORD

A-17 5680-2

(Rectangular)
Oregon

1. T 15S R 9E No. A-17 Cor. Sec. Mer Will State N. F. Deschutes

Dist. Sisters

2. Corner Status

34 35 7/14S
3 7/15S

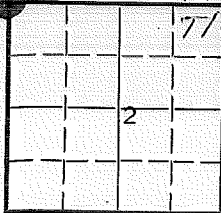

3. Original Description _____ Vol. _____ Page _____ Where Recorded _____

4. Description of Corners:

5. Investigation Notes: See T14S, R9E, Z-17

REC by BLM, 1966

7. Photo Identification

Photo No. _____

Ident. By: _____

8. Plane Coordinate Position Data

State _____ Zone _____

X _____

Y _____

Estab. By _____

Field Book No. _____

Where Filed _____

9. Evaluation

Authentic _____

Needs Verif. _____ Monument _____

Re-estab. _____ Survey _____

Land Status _____

6. Signed C. Wingard Title Hwy. Eng. Date 2-12-63

PERPETUATION RECORD

10. Monument:

11. Accessories

		Field Book _____	Page _____
12. Set By _____ Title _____		13. Recorded By _____	Volume _____ Page _____
License _____	Agency _____	(Agency)	
Date _____		(Date) _____ (City) _____	(County) _____ (State) _____

14. Remarks:

LAND CORNER RECORD

A-19 5680-2

(Rectangular)

1. T 15S R 9E No. A-19 Cor. 1/4 Mer. Will State Oregon N. F. Deschutes Dist. Sisters

2. Corner Status

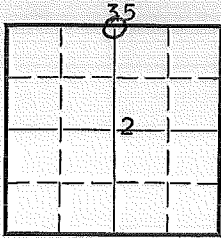

3. Original Description _____ Vol. _____ Page _____ Where Recorded _____

4. Description of Corners: 9-29-1870

5. Investigation Notes: See T14S, R9E, Z-19
No evidence.

7. Photo Identification

Photo No. _____

Ident. By: _____

8. Plane Coordinate Position Data

State _____ Zone _____

X _____

Y _____

Estab. By _____

Field Book No. _____

Where Filed _____

9. Evaluation

Authentic _____

Needs Verif. _____ Monument _____

Re-estab. _____ Survey _____

Land Status _____

SF/NF

6. Signed O. Tringvold Title Hwy. Eng. Date 2-12-63

PERPETUATION RECORD

10. Monument:

11. Accessories

		Field Book	Page			
12. Set By	Title	13. Recorded By	Volume	Page		
License	Agency	Date	(Agency)			
			(Date)	(City)	(County)	(State)

14. Remarks:

LAND CORNER RECORD

A-21 5680-2

1. T 15S R 9E No. A-21 Cor. 4 Mer. Will State Oregon (Rectangular)
N. F. Deschutes Dist. Sisters

2. Corner Status

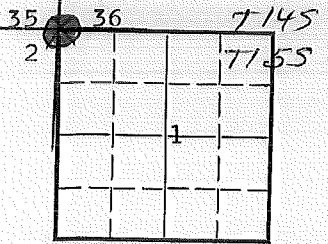

3. Original Description _____ Vol. _____ Page _____ Where Recorded _____

4. Description of Corners:

5. Investigation Notes: See T14S, R9E, Z-21

7. Photo Identification

Photo No. _____
Ident. By: _____

8. Plane Coordinate Position Data

State _____ Zone _____
X _____
Y _____
Estab. By _____
Field Book No. _____
Where Filed _____

9. Evaluation

Authentic _____
Needs Verif. _____ Monument _____
Re-estab. _____ Survey _____
Land Status _____

*PC
by CWL
1972*

6. Signed C. Tringuello Title _____ Hwy. Eng. _____ Date 2-12-63

PERPETUATION RECORD

10. Monument:

11. Accessories

12. Set By _____ Title _____		Field Book _____	Page _____
License _____	Agency _____	Date _____	
13. Recorded By _____ (Agency) _____		Volume _____	Page _____
(Date) _____	(City) _____	(County) _____	(State) _____

14. Remarks:

LAND CORNER RECORD

A-23 5680-2

1. T. 15S. R9 E. No. A-23 Cor. $\frac{1}{4}$ Mer. Will State Oregon (Rectangular) N. F. Deschutes

Dist. Sisters

2. Corner Status

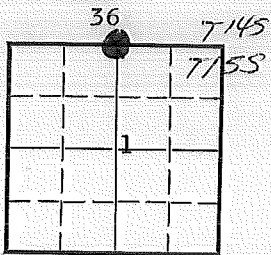

3. Original Description _____ Vol. _____ Page _____ Where Recorded _____

4. Description of Corners:
 (See Z-23, T. 14 S., R. 10 E., W.M.)

5. Investigation Notes:

*BC
 by CWK
 1972*

7. Photo Identification

Photo No. _____
 Ident. By: _____

8. Plane Coordinate Position Data

State _____ Zone _____
 X _____
 Y _____
 Estab. By _____
 Field Book No. _____
 Where Filed _____

9. Evaluation

Authentic _____
 Needs Verif. _____ Monument _____
 Re-estab. _____ Survey _____
 Land Status _____

6. Signed *O. Hingwall* Title Hwy. Eng. Date 6-11-63

PERPETUATION RECORD

10. Monument:

11. Accessories

Field Book _____ Page _____

12. Set By _____ Title _____

License _____ Agency _____ Date _____

13. Recorded By _____ Volume _____ Page _____
(Agency)

(Date) (City) (County) (State)

14. Remarks:

LAND CORNER RECORD

A-25 5680-2
Dist. Sisters

1. T 15S R 9E No. A-25 Cor. Sec. Mer. Will State (Rectangular) Oregon N. F. Deschutes

2. Corner Status

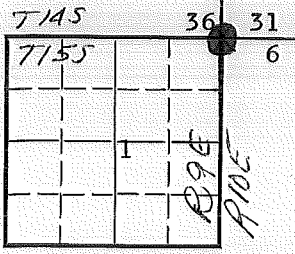

3. Original Description _____ Vol. _____ Page _____ Where Recorded _____

4. Description of Corners:

5. Investigation Notes: See T14S, R9E, Z-25

BC by BM

7. Photo Identification

Photo No. _____

Ident. By: _____

8. Plane Coordinate Position Data

State _____ Zone _____

X _____

Y _____

Estab. By _____

Field Book No. _____

Where Filed _____

9. Evaluation

Authentic _____

Needs Verif. _____ Monument _____

Re-estab. _____ Survey _____

Land Status _____

6. Signed *O. Thingvall* Title _____ Hwy. Eng. _____ Date 2-11-63

PERPETUATION RECORD

10. Monument:

11. Accessories

12. Set By _____ Title _____
License _____ Agency _____ Date _____

Field Book _____ Page _____
13. Recorded By _____ Volume _____ Page _____
(Agency)
(Date) (City) (County) (State)

14. Remarks:

Index
File No. 2558 **CORNER RECORD (SEARCH)** Tract or Survey No. 000229 Cor. No. B-25
(Ref. FSM 7151.4)
T 15 S. R. 9 E. R.D. SISTERS County DESCHUTES 5/16 Cor.
Merid. WILLAMETTE N.F. DESCHUTES State OREGON Sec. 1/6

SEE: B-01

T155 R10E

S. R. 9
E. 610
2/80

000229

B-25

LAND CORNER RECORD

C-1 5680-2

1. T 15S R 9E No. C-1 Cor. 1/4 Mer. Will State Oregon N. F. Deschutes Dist. Sisters

2. Corner Status

3. Original Description _____ Vol. _____ Page _____ Where Recorded _____

4. Description of Corners:

~~(See C-25, T15S, R9E, W.M.)~~

SF NF

5. Investigation Notes:

7. Photo Identification

Photo No. _____

Ident. By: _____

8. Plane Coordinate Position Data

State _____ Zone _____

X _____

Y _____

Estab. By _____

Field Book No. _____

Where Filed _____

9. Evaluation

Authentic _____

Needs Verif. _____ Monument _____

Re-estab. _____ Survey _____

Land Status _____

SF / NF

S. CHAMBERLAIN

8-15-83

6. Signed S. Chamberlain Title Hwy. Eng. Date 6-4-63

PERPETUATION RECORD

10. Monument:

11. Accessories

12. Set By _____ Title _____
License _____ Agency _____ Date _____

13. Recorded By _____ (Agency) _____ Volume _____ Page _____
(Date) (City) (County) (State)

14. Remarks:

Index
File No. 5/17

CORNER RECORD (SEARCH) Contract or
(Ref. FSM 7151.4) Survey No. 4-1 Cor. No. C/5

T 15 S. R. 9 E. R.D. Sisters County Deschutes 1/4 Cor. of
Merid. Willamette N.F. Deschutes State Oregon Sections 6 & 5

CORNER DIAGRAM, per legend

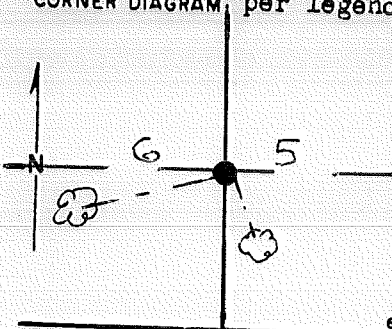

DESCRIBE CORNER MONUMENT FOUND

SENT

DESCRIBE BEARING TREES OR OTHER OFFICIAL ACCESSORIES FOUND

None

PHOTO IDENTIFICATION DATA

Photo No. _____
Filed At. _____
Object Ident. _____
Ident. By _____
Signature

DESCRIBE CORNER LOCATION RELATIVE TO NEAR-BY FEATURES, ALSO HOW TO REACH CORNER

CORNER LEGEND:

- FS or Unverified
- Contr. Other
- ◇ Searched For/Not Found
- ⊗ ⊗ Evidence Found/Accept.
- ◆ Permanent Mon. Set/Pd.

Searched By: Fred Ast Title PLS Division _____ Headquarters _____ Date 5/85

CORNER RECORD (PERPETUATION)

MONUMENT. DESCRIBE NEW MONUMENT SET, OR WORK DONE TO PRESERVE EXISTING MONUMENT

Set 2 1/2' x 30" I.P. b.c.d. RSG 0.4' 1A

stone mound

'single proportioned'

MONUMENT STAMP

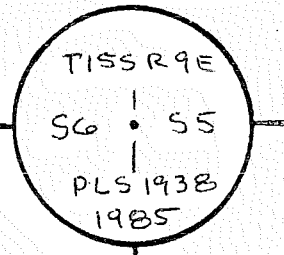

ACCESSORIES DESCRIBE NEW BT'S WITNESS OBJECTS ETC. ESTABLISHED, OR WORK DONE TO PRESERVE EXISTING EVIDENCE

Scribed B.T.S.'s: 10" pipe - S 73 1/2° W @ 17' 0"

8" pipe - S 16° E @ 6' 0"

60d SPIKES w/ PLS 1938" ALUM. WASHERS WERE DRIVEN INTO SIDE CENTER BASE

Work Done By Fred Ast Title PLS Date 5/85 State Registration No. 1938
or Agency

Flat or Certified for Record Prepared? Yes No Filed At Desch Co. Surveyor's Office Date 6/85

History of Surveys, G.L.O., etc. 1870 - GLO - J. McClure

Index File No. 5/17 T. 15 S., R. 9 E., W.M.

Contract or Surv. No. 4-1

Cor. C/5

Index File No. 09/53

CORNER RECORD (SEARCH) Contract or Survey No. 4-1
 (Ref. FSM 7151.4)

Cor. No. c/g

T 15 S. R. 9 E. R.D. Sisters County Deschutes State Oregon 1/4 Cor. of Sections 5 & 4
 Merid. Willamette N.F. Deschutes

CORNER DIAGRAM per Legend

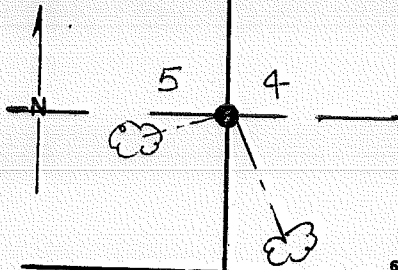

DESCRIBE CORNER MONUMENT FOUND

SFNF

DESCRIBE BEARING TREES OR OTHER OFFICIAL ACCESSORIES FOUND

None

PHOTO IDENTIFICATION DATA

Photo No. _____
 Filed At. _____
 Object Ident. _____
 Ident. By _____
 Signature _____

DESCRIBE CORNER LOCATION RELATIVE TO NEAR-BY FEATURES, ALSO HOW TO REACH CORNER

XING TAG ON TRUSS DIRT ROAD

270' ±

5 ● 4

CORNER LEGEND:

- | | | |
|--------------|------------------|------------------------|
| FS or Contr. | Unverified Other | |
| ○ | ◇ | Searched For/Not Found |
| ⊗ | ⊗ | Evidence Found/Accept. |
| ● | ◆ | Permanent Mon. Set/Pd. |

Searched By: Fred Ast

Title PLS

Division _____

Headquarters _____

Date 5/85

CORNER RECORD (PERPETUATION)

MONUMENT. DESCRIBE NEW MONUMENT SET, OR WORK DONE TO PRESERVE EXISTING MONUMENT

set 2 1/2" x 30" l.p. b.c.d. r.s.g o.3'

in stone collar

'single proportioned'

MONUMENT STAMPE

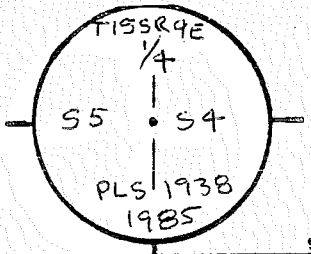

ACCESSORIES DESCRIBE NEW BT'S WITNESS OBJECTS ETC. ESTABLISHED, OR WORK DONE TO PRESERVE EXISTING EVIDENCE

Scribed b.t.s.: 7" p. pine - S 61° W @ 9.50' (1/4 S5 BT)

BTs Found as stumps 8/87 7" p. pine - S 15 1/2° E @ 26.49' (1/4 S4 BT)

SET BEARING OBJECTS AS FOLLOWS:

- 1) #5 x 24" SR w/ 1 1/2" AC BRS N 48° 12' E AT 12.42'
- 2) #5 x 24" " " " " N 46° 56' W " 11.60'

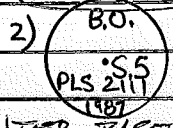
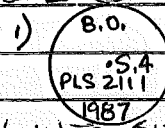

Good SPICE w/ "PLS 1938" ALUM. WASHER WAS DRIVEN INTO SIDE CENTER BASE TO

Work Done By Fred Ast Title PLS Date 5/85 State Registration No. 1978 or Agency

Planned For Record Prepared? (Yes) No Filed At Deer Co. Surveyor's Office Date 6/85

History of Surveys, G.L.O., etc.

1870 - GLO - J. McCullough

Mte By Walt Miller - PLS 2111 (8/87)

Index File No. 9/53 T. 15 S., R. 9 E., W.M.

Contract or Surv. No 4-1

Cor. C/9

Index File No. 13-53 CORNER RECORD (SEARCH) Contract or Survey No. 4-1 Cor. No. C-13
 (Ref. FSM 7151.4)
 T. 15 S. R. 9 E. R.D. SISTERS County Deschutes E 1/4 Cor. of
 Merid. Willamette N.F. Deschutes State Oregon Section 4

CORNER DIAGRAM per Legend

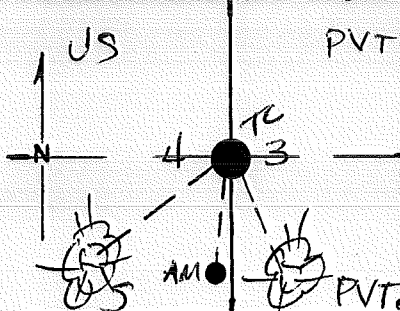

DESCRIBE CORNER MONUMENT FOUND

FD., BUT DID NOT HOLD A
 2 1/2" BC'D I.P. SET BY B. ROGERS, DUE TO A
 PROPORTIONING ERROR

DESCRIBE BEARING TREES OR OTHER OFFICIAL ACCESSORIES FOUND

FD B. ROGERS B.T.'S AND USED SAME FOR
 B.T.'S TO MONUMENT SET DURING MY
 SURVEY (4-1)

PHOTO IDENTIFICATION DATA

Photo No. _____
 Filed At. _____
 Object Ident. _____
 Ident. By _____
 Signature _____

SEE REVERSE SIDE FOR BEARINGS &
 DISTANCES.

DESCRIBE CORNER LOCATION RELATIVE TO NEAR-BY FEATURES, ALSO HOW TO REACH CORNER

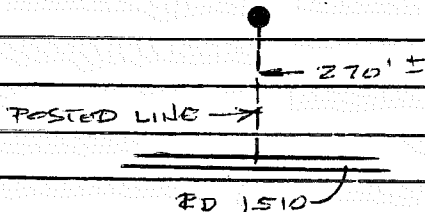

CORNER LEGEND:

- | | | |
|--------|------------|------------------------|
| FS or | Unverified | |
| Contr. | Other | |
| ○ | ◇ | Searched For/Not Found |
| ⊗ | ⊗ | Evidence Found/Accept. |
| ● | ◆ | Permanent Mon. Set/Fd. |

Searched By: FRED ABT Title P.L.S. Division _____ Headquarters _____ Date 5/85

CORNER RECORD (PERPETUATION)

MONUMENT. DESCRIBE NEW MONUMENT SET, OR WORK DONE TO PRESERVE EXISTING MONUMENT

SET 2 1/2" x 30" BC'D. I.P., RSG 0.3', IN A STONE COLLAR

(SINGLE PROPORTIONED)

MONUMENT STAMPED

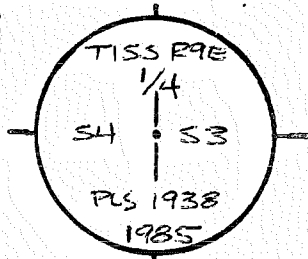

ACCESSORIES DESCRIBE NEW BT'S WITNESS OBJECTS ETC. ESTABLISHED, OR WORK DONE TO PRESERVE EXISTING EVIDENCE

BT'S (SCRIBED BY B. ROGERS) 7" P. PINE - S54 3/4° W, 34.72'

8" P. PINE - S13° E, 27.66'

"ROGERS 2 1/2" BC'D. I.P., BEARS S01°48'29"W, 9.84' FROM MONUMENT SET DURING THIS SURVEY (4-1)

STAMPED MONUMENT "AM 1985" AS SHOWN

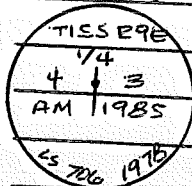

Work Done By: FRED AUST Title: PLS Date: 5/85 State Registration No. or Agency: 1938

Plat or Cor Record Prepared? (Yes) No Filed At: Desch Co. Surveyor's Office Date: 6/85

History of Surveys, G.L.O., etc. 1870 - G.L.O. - J. McCLUNG 1978 - "OVERPASS SALE" CADASTRAL - B. ROGERS

Index File No. 13-53 T. 15 S., R. 9 E., W.M. Contract or Surv. No 4-1 Cor. C-13

Index File No. 17-53 CORNER RECORD (SEARCH) (Ref. FSM 7151.4) Contract or Survey No. 4-1 Cor. No. C-17
 T 15 S. R. 9 E. R.D. SISTERS County Deschutes E/4 Cor. of Merid. Willamette N.F. Deschutes State Oregon Section 3

CORNER DIAGRAM per legend

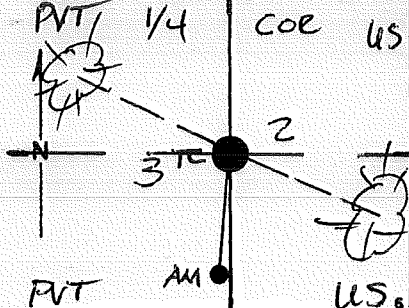

DESCRIBE CORNER MONUMENT FOUND
 Fd., BUT DID NOT HOLD A
 2 1/2" B.C.D. I.P., SET BY B. ROGERS, DUE TO A
 PROPORTIONING ERROR.

DESCRIBE BEARING TREES OR OTHER OFFICIAL ACCESSORIES FOUND
 Fd B. ROGERS B.T.'S AND USED SAME FOR
 B.T.'S TO MONUMENT SET DURING MY
 SURVEY (4-1)

PHOTO IDENTIFICATION DATA

Photo No. _____
 Filed At. _____
 Object Ident. _____
 Ident. By _____
 Signature _____

SEE REVERSE SIDE FOR BEARINGS &
 DISTANCES

DESCRIBE CORNER LOCATION RELATIVE TO NEAR-BY FEATURES, ALSO HOW TO REACH CORNER
 RD 1510-450

- CORNER LEGEND:
- | | | |
|--------------|------------------|------------------------|
| PS or Contr. | Unverified Other | |
| ○ | ◇ | Searched For/Not Found |
| ⊗ | ⊗ | Evidence Found/Accept. |
| ● | ◆ | Permanent Mon. Set/Fd. |

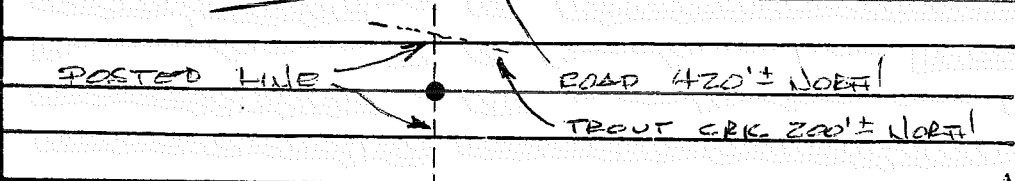

Searched By: FRED AST Title P.L.S. Division _____ Headquarters _____ Date 5/85

CORNER RECORD (PERPETUATION)

MONUMENT. DESCRIBE NEW MONUMENT SET, OR WORK DONE TO PRESERVE EXISTING MONUMENT

SET 2 1/2" x 30" B.C'd. I.P., BSS 0.6' IN A STAKE
MOUND, (SINGLE PROPORTIONED)

MONUMENT STAMPED

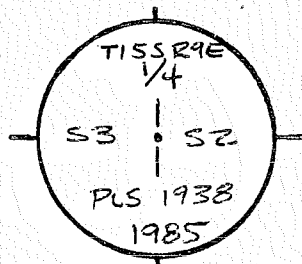

ACCESSORIES DESCRIBE NEW BT'S WITNESS OBJECTS ETC. ESTABLISHED, OR WORK DONE TO PRESERVE EXISTING EVIDENCE

B.T.'S (SCRIBED BY B. ROGERS) 8" P.PINE - N61 1/4° W, 3.01'

7" P.PINE - S63° E, 12.52'

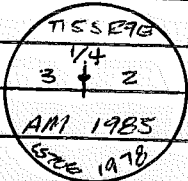

"ROGERS 2 1/2" B.C'd. I.P. BEARS S01°56'46" E, 12.47' FROM MON-
UMENT SET DURING THIS SURVEY (4-1)

STAMPED MONUMENT "AM 1985" AS SHOWN

Work Done By FRED AST Title P.L.S. Date 5/85 State Registration No. 1938
or Agency

Plat or Record Prepared? Yes No Filed At DESCH. Co. Surveyor's Office Date 6/85

History of Surveys, G.L.O., etc.
1870 - GLO - J. McCLUNG
1978 - "OVERPASS SALE" CADASTRAL - B. ROGERS

Index File No. 17-53 T. 15 S., R. 9 E., W.M. Contract or Surv. No. 4-1 Cor. C-17

LAND CORNER RECORD

(000130)

C-21 5680-2

(Rectangular)

1. T 15S R 9E No. C-21 Cor. 1 Mer. Will State Oregon N. F. Deschutes Dist. Sisters

2. Corner Status

3. Original Description Vol. Page Where Recorded

4. Description of Corners: 1870 - Set stone 16x13x7 for 1/4 sec. cor.

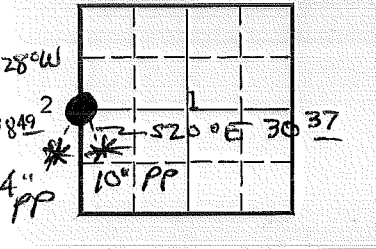

5. Investigation Notes: At time of original survey, the surveyor failed to leave sufficient evidence for corner identification.

7. Photo Identification

Photo No. _____
Ident. By: _____

8. Plane Coordinate Position Data

State _____ Zone _____
X _____
Y _____
Estab. By _____
Field Book No. _____
Where Filed _____

2" X 36" STEEL PIPE w/ 3" BRASS CAP SET
AS INITIAL POINT for CROSSROADS FIRST
ADDITION SUBDIVISION BY JAMES E. BUSSARD
PLS OR-599 in 1972, PLAT Book 11, P. 43.
RP's: 10" PP 520°E 30.37 FT.
A" PP 528°E 1849 FT.

9. Evaluation

Authentic _____
Needs Verif. _____ Monument _____
Re-estab. _____ Survey _____
Land Status _____

6. Signed O. Tringvall Title _____ Hwy. Eng. Date 6-4-63

PERPETUATION RECORD

10. Monument:

11. Accessories

Field Book _____ Page _____

12. Set By _____ Title _____

13. Recorded By _____ Volume _____ Page _____
(Agency)

License _____ Agency _____ Date _____

(Date) _____ (City) _____ (County) _____ (State) _____

14. Remarks:

(PLAT # 100130)

C-21

Index File No. 2353

CORNER RECORD (SEARCH)
(Ref. FSM 7151.4)

Tract or Survey No. 000130 Cor. No. C-23

T. 15S R. 9E R.D. Sister County Deschutes C/A Sec 1
 Merid. Will N.F. Deschutes State Oregon

CORNER DIAGRAM

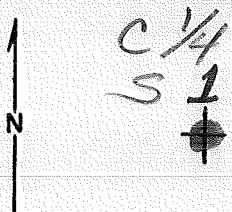

DESCRIBE CORNER MONUMENT FOUND

2 1/2" Steel Pipe w/Brass Cap Set By James E. Bussard PLS. OR-599 in 1972

DESCRIBE BEARING TREES OR OTHER OFFICIAL ACCESSORIES FOUND

RP's : 6" PP 5 04° E 19 1/2 FT.
 8" PP 5 34° W 35 1/2 FT.

PHOTO IDENTIFICATION DATA

Photo No. _____
 Filed At. _____
 Object Ident. _____
 Ident. By _____
 Signature _____

PLANE COORDINATE POSITION DATA

State _____ Zone _____
 X _____
 Y _____
 Estab. By _____
 Agency _____

DESCRIBE CORNER LOCATION RELATIVE TO NEAR-BY FEATURES, ALSO HOW TO REACH CORNER

Signature Dan Sanwick Title Surveyor Division Eng. Headquarters SO Date 8/78 7100-52 (3 68)

CORNER RECORD (PERPETUATION)

MONUMENT
STAMPED:

MONUMENT : DESCRIBE NEW MONUMENT SET, OR WORK DONE TO PRESERVE EXISTING MONUMENT

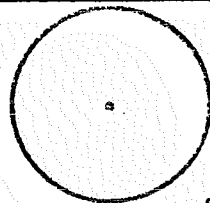

ACCESSORIES : DESCRIBE NEW BT's WITNESS OBJECTS ETC. ESTABLISHED, OR WORK DONE TO PRESERVE EXISTING EVIDENCE

Work Done By _____ Title _____ Date _____ State Registration No. or Agency _____

Certified Cor. Record Prepared ? Yes No Filed At: _____ Date _____

REMARKS

Index File No. 2353 T. 15 S.R. 9 E.W.M.

Tract or Surv. No. 000130

Cor. C-23

LAND CORNER RECORD

(600130)

C-25 5680-2

(Rectangular)

1. T 15S R 9E No. C-25 Cor. 1/4 Mer. Will State Oregon N. F. Deschutes Dist. Sisters

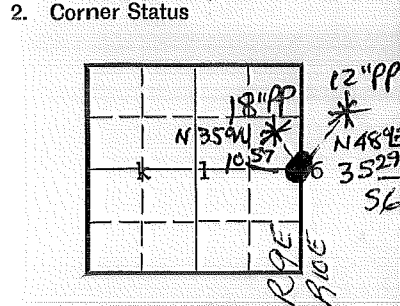

3. Original Description _____ Vol. _____ Page _____ Where Recorded _____

4. Description of Corners: 1870 Set stone 12x10x8 for 1/4 sec. cor.

5. Investigation Notes: At time of original survey, the surveyor failed to leave sufficient evidence for corner identification.

7. Photo Identification
 Photo No. _____
 Ident. By: _____

8. Plane Coordinate Position Data
 State _____ Zone _____
 X _____
 Y _____
 Estab. By _____
 Field Book No. _____
 Where Filed _____

9. Evaluation
 Authentic _____
 Needs Verif. _____ Monument _____
 Re-estab. _____ Survey _____
 Land Status _____

2 1/2" Steel pipe w/ BRASS CAP SET BY
 JAMES E BUSSARD PLS OR-599 in 1972
 In Top of Cut Bank OR. ST. HWY. 242 BY
 Fence Cor. f/w the NE Abutment of the
 Hwy. Overpass lies 116 1/2 ft WSW
 RPs: 1" PP S20°W 668 FT.
 6" PP N80°W 2459 FT. over

6. Signed O. Tringvall Title _____ Hwy. Eng. Date 6-4-63

PERPETUATION RECORD

10. Monument:

11. Accessories

BTS by U&W (000MA1)

5" PP S70°E 1552 FT B/S 1/2 56 BT

6" PP N10°W 926 FT B/S 1/4 51 BT

Field Book _____ Page _____

12. Set By _____ Title _____

License _____ Agency _____ Date _____

13. Recorded By _____ Volume _____ Page _____
(Agency)

(Date) _____ (City) _____ (County) _____ (State) _____

14. Remarks:

Index
File No. 2354
T 15S R. 9E
Merid. Will

CORNER RECORD (SEARCH)
(Ref. FSM 7151.4)
R.D. Sister's County Deschutes
N.F. Deschutes State Oregon

Tract or
Survey No. 000130 Cor. No. D-23
SC/16 Cor Sec 1

CORNER DIAGRAM

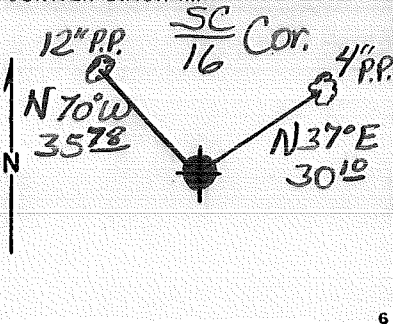

DESCRIBE CORNER MONUMENT FOUND

A 2 1/2" Steel Pipe w/ 3" Brass Cap
Set by James E. Bussard
PLS-699 in 1972

DESCRIBE BEARING TREES OR OTHER OFFICIAL ACCESSORIES FOUND

PHOTO IDENTIFICATION DATA

Photo No. _____
Filed At. _____
Object Ident. _____
Ident. By _____
Signature

DESCRIBE CORNER LOCATION RELATIVE TO NEAR-BY FEATURES, ALSO HOW TO REACH CORNER

PLANE COORDINATE POSITION DATA

State _____ Zone _____
X _____
Y _____
Estab. By _____
Agency

Signature Daniel Shankwich Title Survey Tech Division Eng. Headquarters SO Date 8/78 7100-52 (3 68)

CORNER RECORD (PERPETUATION)

MONUMENT
STAMPED:

MONUMENT: DESCRIBE NEW MONUMENT SET, OR WORK DONE TO PRESERVE EXISTING MONUMENT

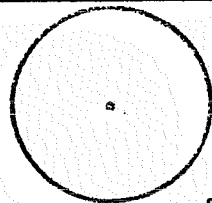

9

ACCESSORIES : DESCRIBE NEW BT'S WITNESS OBJECTS ETC. ESTABLISHED, OR WORK DONE TO PRESERVE EXISTING EVIDENCE

10

Work Done By _____ Title _____ Date _____ State Registration No.
or Agency _____

Certified Cor. Record Prepared ? Yes No Filed At: _____ Date _____

11

REMARKS

12

Index File No. T. R. M. Tract or Surv. No. Cor. *D-23*

13

Index File No. 2554

CORNER RECORD (SEARCH)

(Ref. FSM 7151.4)

Tract or Survey No. 000130 Cor. No. D-25

T 15S R. 9E

R.D. Sister's County Deschutes 9/16 Cor Sec. 146

Merid. Will

N.F. Deschutes State Oregon

CORNER DIAGRAM

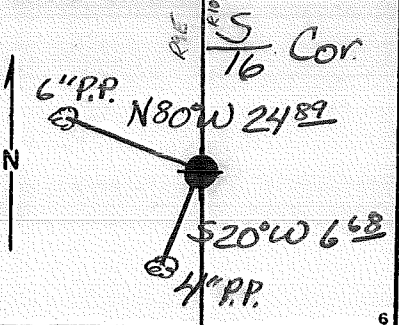

DESCRIBE CORNER MONUMENT FOUND

A 2 1/2" Steel Pipe w/3" Brass Cap
Set by James E. Bussard
PLS-699 in 1972

DESCRIBE BEARING TREES OR OTHER OFFICIAL ACCESSORIES FOUND

PHOTO IDENTIFICATION DATA

Photo No. _____
Filed At. _____
Object Ident. _____
Ident. By _____
Signature

DESCRIBE CORNER LOCATION RELATIVE TO NEAR-BY FEATURES, ALSO HOW TO REACH CORNER

PLANE COORDINATE POSITION DATA

State _____ Zone _____
X _____
Y _____
Estab. By _____
Agency

Signature Dan Sandwich Title Survey Tech Division Eng. Headquarters S.O. Date 8/78 7100-52 (3 68)

CORNER RECORD (PERPETUATION)

MONUMENT
STAMPED:

MONUMENT : DESCRIBE NEW MONUMENT SET, OR WORK DONE TO PRESERVE EXISTING MONUMENT

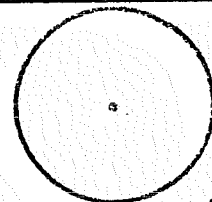

9

ACCESSORIES : DESCRIBE NEW BT'S WITNESS OBJECTS ETC. ESTABLISHED, OR WORK DONE TO PRESERVE EXISTING EVIDENCE

10

Work Done By _____ Title _____ Date _____ State Registration No. or Agency _____

Certified Cor. Record Prepared ? Yes No Filed At _____ Date _____

11

REMARKS

12

Index File No. T. R. M. Tract or Surv. No. Cor. *D-25*

13

Index File No. 0155 CORNER RECORD (SEARCH) Contract or Survey No. _____
 (Ref. FSM 7151.4)
 T 15 S. R. 9 E. R.D. Sisters County Deschutes NE Cor. of
 Merid. Willamette N.F. Deschutes State Oregon Section 7

CORNER DIAGRAM per legend

DESCRIBE CORNER MONUMENT FOUND

FND CIRCLE OF STONES WITH A STONE IN THE CENTER 11" X 10" X 9" WITH NO MARKS.

DESCRIBE BEARING TREES OR OTHER OFFICIAL ACCESSORIES FOUND

SFNF

PHOTO IDENTIFICATION DATA

Photo No. _____
 Filed At. _____
 Object Ident. _____
 Ident. By _____

DESCRIBE CORNER LOCATION RELATIVE TO NEAR-BY FEATURES, ALSO HOW TO REACH CORNER

Signature _____

CORNER LEGEND:

- FS or Contr. Unverified Other
- ◇ Searched For/Not Found
 - ⊗ ⊗ Evidence Found/Accept.
 - ◆ Permanent Mon. Set/Yd.

Searched By: W. Miller

Title

PLS

Division

CS

Headquarters

SO

Date

6/06

CORNER RECORD (PERPETUATION)

MONUMENT STAMPED

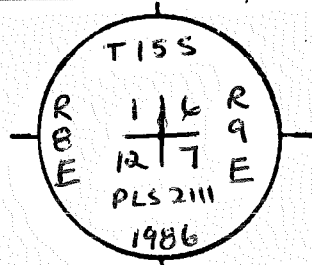

MONUMENT. DESCRIBE NEW MONUMENT SET, OR WORK DONE TO PRESERVE EXISTING MONUMENT

Set a 2 1/2" x 30" BCSP rising 5" in a stone mound at the centroid location of the original stone used in the control traverse, MKD:

ACCESSORIES DESCRIBE NEW BT'S WITNESS OBJECTS ETC. ESTABLISHED, OR WORK DONE TO PRESERVE EXISTING EVIDENCE

- 1) A 16" W.F.R, brs S 61° 07' E @ 21¹⁰ FT, to a 60-d nail w/brass washer (LS2111) in the NNE base, marked T15SRBES1BT.
- 2) A 15" W.F. brs S 56° 11' W @ 33²⁰, " " " " in S base, MKD T15SRBES12BT
- 3) ~~A~~ A 4" W.F. brs S 89° 37' W @ 29⁰¹ FT, " " " " " S base, MKD " X BT"
- *A 17" W.F. brs N 07° 08' W @ 37⁷ FT, " " " " " ESE base, " T15SRBES1BT

Work Done By W. Miller Title PLS Date 6/86 State Registration No. 2111 or Agency

Platted For Record Prepared? (Yes) No Filed At Desch. Co. Surveyor's Office Date 7/23/86

History of Surveys, G.L.O., etc.

*Note: there were NO AVAILABLE ACCESSORIES IN THE NE QUADRANT
SEE PLAT NO 000705

Index File No. T. S., R. E., W.M. Contract or Surv. No. Cor.

0155 15 9 E-01

Index File No. 0355

CORNER RECORD (SEARCH) Contract or

Cor. E-03

(Ref. FSM 7151.4)

Survey No. _____

No. ~~E-05~~

T 15 S. R. 9 E.

R.D. SISTERS

County DESCHUTES

N/A

Cor. of

Merid. Willamette

N.F. Deschutes

State Oregon

Section 7

CORNER DIAGRAM per legend

DESCRIBE CORNER MONUMENT FOUND

SFNF

DESCRIBE BEARING TREES OR OTHER OFFICIAL ACCESSORIES FOUND

SFNF

DESCRIBE CORNER LOCATION RELATIVE TO NEAR-BY FEATURES, ALSO HOW TO REACH CORNER

AREA LOGGED OVER AND CATTED.

PHOTO IDENTIFICATION DATA

Photo No. _____

Filed At. _____

Object Ident. _____

Ident. By _____

Signature _____

CORNER LEGEND:

FS or Unverified

Contr. Other

○ ◊ Searched For/Not Found

⊗ ⊗ Evidence Found/Accept.

● ◆ Permanent Mon. Set/Yd.

Searched By: W. Miller

Title

PLS

Division

CS

Headquarters

SO

Date

6/86

CORNER RECORD (PERPETUATION)

MONUMENT STAMPED

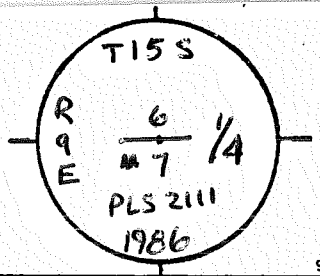

MONUMENT. DESCRIBE NEW MONUMENT SET, OR WORK DONE TO PRESERVE EXISTING MONUMENT

SET, AT THE PRORATED POINT, A 2 1/2" x 30" BCSP
RISING 5" IN STONE COLLAR MKD:

ACCESSORIES DESCRIBE NEW BT'S, WITNESS OBJECTS ETC. ESTABLISHED, OR WORK DONE TO PRESERVE EXISTING EVIDENCE

1) A 9" W. Fir brs N54°41'E @ 32.16 FT TO a 60-d nail w/ brass washer (LS 2111) in the SE base, MKD 1/4 S6 BT.

2) AN 11" W. Fir brs S42°21'W @ 16.41 FT TO a 60-d nail w/ brass washer (LS 2111) IN NW base, MKD 1/4 S7 BT

Both trees dead 4/28/94, have been High stumped M.W. / s.o.

Work Done By W. Miller Title PLS Date 6/96 State Registration No. 2111
or Agency

Flat or Record Prepared? (Yes) No Filed At Desch Co. Surveyor's Office Date 7/22/86

History of Surveys, G.L.O., etc.

See plat No 000705

Index File No.

T. 15 S., R. 9 E., W.M.

Contract or Surv. No

Cor.

0355

E-03

USDA-FOREST SERVICE D-7100-52(2/82)

Index

File No.

5/55

CORNER RECORD (SEARCH) Contract or

(Ref. FSM 7151.4)

Survey No.

4-1

Cor. No.

E/5

T 15 S. R. 9 E.

R.D. Sisters

County Deschutes

STD. Cor. of

Merid. Willamette

N.F. Deschutes

State Oregon

Section 5, 6, 7 & 8

CORNER DIAGRAM per legend

DESCRIBE CORNER MONUMENT FOUND



END 3/4" U.S. B.L.M. B.C.

on a 2 1/2" i.p. Rsg. 0.3'

DESCRIBE BEARING TREES OR OTHER OFFICIAL ACCESSORIES FOUND

18" W Fir - N14°W @ 44 LKS

8" p.p. re - N46°E @ 14 1/2 LKS

8" p.p. re - S30°E @ 50 LKS

8" P.P. re SNAG - S49°W @ 4 LKS - 28" P.P. re ^(original) S7 1/2°W @ 2 1/2'

PHOTO IDENTIFICATION DATA

Photo No.

Filed At.

Object Ident.

Ident. By

Signature

CORNER LEGEND:

FS or Unverified
Constr. Other

○ ◇ Searched For/Not Found

⊗ ⊗ Evidence Found/Accept.

● ◆ Permanent Mon. Set/Pl.

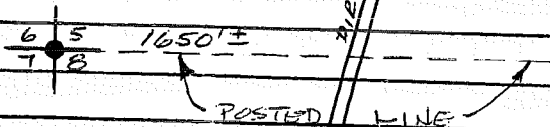

Searched By: FKED AST

Title PLS

Division

Headquarters

Date

5/85

CORNER RECORD (PERPETUATION)

MONUMENT. DESCRIBE NEW MONUMENT SET, OR WORK DONE TO PRESERVE EXISTING MONUMENT

NONE RESP'D

MONUMENT STAMP

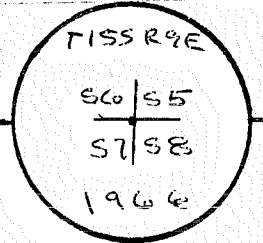

9

ACCESSORIES DESCRIBE NEW BT'S WITNESS OBJECTS ETC. ESTABLISHED, OR WORK DONE TO PRESERVE EXISTING EVIDENCE

NONE RESP'D
Walt Miller (6/86) PLS-2111 - Set new BT to Replace ORIG.
1) A 5" P. PINE bRS S77°W @ 37.82' to a 60-d nail w/brass washer (LS 2111) in SSE base MARKED "X BT"

10

Work Done By Ered BT Title PLS Date 5/85 State Registration No. 1938
or Agency
 Plat of Record Prepared? Yes No Filed At DeScha Co. Surveyor's Office Date 6/85

11

History of Surveys, G.L.O., etc.
1870 - GLO - J. McCLUNG
1966 - BLM REMONUMENTATION - J. E. JELLEY
SEE: 000705

12

Index File No. S/55 T. 15 S., R. 9 E., W.M. Contract or Surv. No. 4-1 Cor. E/8

13

USDA-FOREST SERVICE D-7100-52(2/82)

Index

File No. 7/55

CORNER RECORD (SEARCH)

Contract or

(Ref. FSM 7151.4)

Survey No. 4-1

Cor.

No. E/7

T 15 S. R. 9 E. R.D. Sisters

County Deschutes

5/4

Cor. of

Merid. Willamette

N.F. Deschutes

State Oregon

Section 5

CORNER DIAGRAM per Legend

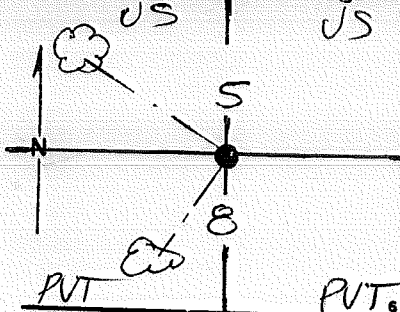

DESCRIBE CORNER MONUMENT FOUND

SFNF

DESCRIBE BEARING TREES OR OTHER OFFICIAL ACCESSORIES FOUND

NONE

PHOTO IDENTIFICATION DATA

Photo No. _____

Filed At. _____

Object Ident. _____

Ident. By _____

Signature _____

DESCRIBE CORNER LOCATION RELATIVE TO NEAR-BY FEATURES, ALSO HOW TO REACH CORNER

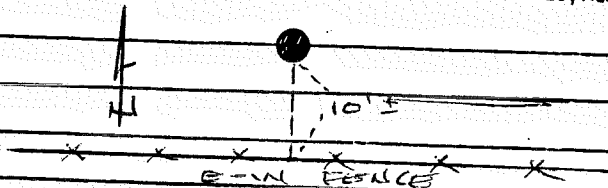

CORNER LEGEND:

FS or Unverified
contr. Other

○ ◇ Searched For/Not Found

⊗ ⊗ Evidence Found/Accept.

● ◆ Permanent Mon. Set/Td.

Searched By: FRED RST Title PLS Division _____

Headquarters _____

Date 5/85

OWNER RECORD (PERPETUATION)

MONUMENT. DESCRIBE NEW MONUMENT SET, OR WORK DONE TO PRESERVE EXISTING MONUMENT

Set 2 1/2" x 30" bcd. Rsg. 0.4" IN Stone collar

"Single proportioned"

MONUMENT STAMPE:

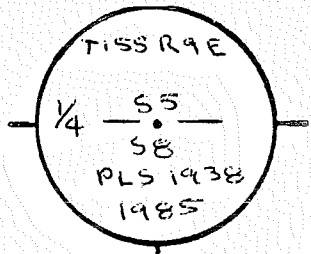

ACCESSORIES DESCRIBE NEW BT'S WITNESS OBJECTS ETC. ESTABLISHED, OR WORK DONE TO PRESERVE EXISTING EVIDENCE

Scribed B.T.S.

8" p. pine - S37 1/2° W @ 39 1/2'

1/4 58 BT

8" p. pine - S51 1/2° W @ 49 1/2'

1/4 55 BT

Good SPIKE W/ "PLS 1938" ALUM. WASHER WAS DRIVEN INTO SIDES CENTER BASE 10

Work Done By Fred Ast Title P.L.S. Date 5/85 State Registration No. 1938 or Agency

Filed For Record Prepared? Yes No Filed At Desca Co. Surveyor's Office Date 6/85 11

History of Surveys, G.L.O., etc. 1870 GLO - J. McCLUNG

Index File No. E/7 T. 15 S., R. 9 E., W.M.

Contract or Surv. No 4-1

Cor. 7/55 12 13

USDA-FOREST SERVICE D-7100-52(2/82)

Index File No. 9/55

CORNER RECORD (SEARCH) Contract or Survey No. 4-1
(Ref. FSM 7151.4)

Cor. No. E/9

T 15 S. R. 9 E. R.D. Sisters

County Deschutes

Cor. of S/E

Merid. Willamette

N.F. Deschutes

State Oregon

Section 5

CORNER DIAGRAM per legend

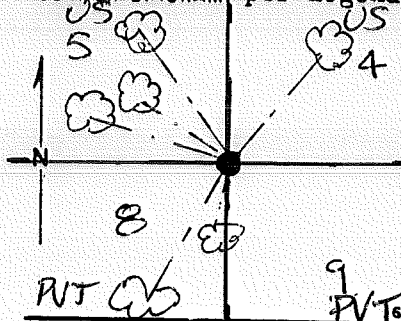

DESCRIBE CORNER MONUMENT FOUND

DESCRIBE BEARING TREES OR OTHER ~~MONUMENT~~ ACCESSORIES FOUND

END-TAGGED as Bearing trees

34" p. pine - N 65 1/2° W @ 56 1/2'

23" p. pine - N 56° W @ 33E'

PHOTO IDENTIFICATION DATA

Photo No. _____

Filed At. _____

Object Ident. _____

Ident. By _____

Signature _____

CORNER LEGEND:

FS or Unverified Contr. Other

○ ◇ Searched For/Not Found

⊗ ⊗ Evidence Found/Accept.

● ◆ Permanent Mon. Set/Id.

DESCRIBE CORNER LOCATION RELATIVE TO NEAR-BY FEATURES, ALSO HOW TO REACH CORNER

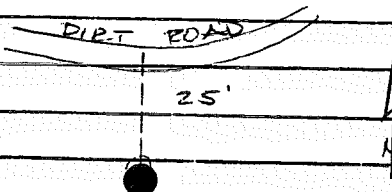

Searched By: Fred Ast

Title PLS

Division

Headquarters

Date 5/85

CORNER RECORD (PERPETUATION)

MONUMENT. DESCRIBE NEW MONUMENT SET, OR WORK DONE TO PRESERVE EXISTING MONUMENT

set 2 1/2" x 30" bed. 1 p., 855 o.s. in stone mound
'double proportioned'

MONUMENT STAMPED

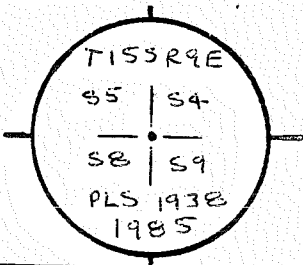

ACCESSORIES DESCRIBE NEW BT'S WITNESS OBJECTS ETC. ESTABLISHED, OR WORK DONE TO PRESERVE EXISTING EVIDENCE

13" p. pine - N 30 1/2° E @ 57' 10"

TISS R9E 55 BT

11" p. pine - N 36° E @ 44' 35"

TISS R9E 54 BT

7" p. pine - S 22 1/4° E @ 82' 73"

TISS R9E 59 BT

10" p. pine - S 16° W @ 17' 55"

TISS R9E 58 BT

60d SPIKE W/ "PLS 1938" ALUM WASHER DRIVEN INTO SIDE CENTER BASE.

Work Done By Fred Ast

Title PLS

Date 5/85

State Registration No. or Agency 1938

Plat or Cor. Record Prepared? Yes

No

Filed At _____ Co. Surveyor's Office Date _____

History of Surveys, G.L.O., etc. 1870 - G.L.O. - J. McCLUNG

Index File No 9/55 T. 15 S., R. 9 E., W.M.

Contract or Surv. No 4-1

Cor. E/9

Index

File No. 11/55

CORNER RECORD (SEARCH) Contract or

(Ref. FSM 7151.4)

Survey No. 4-1

Cor. No. E/11

T 15 S. R. 9 E. R.D. Sisters

County Deschutes

1/4 Cor. of

Merid. Willamette

N.F. Deschutes

State Oregon

Section 4 & 9

CORNER DIAGRAM per legend

DESCRIBE CORNER MONUMENT FOUND

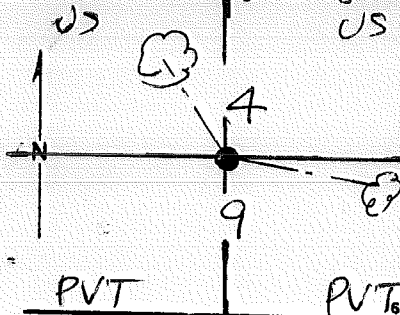

SF NF

DESCRIBE BEARING TREES OR OTHER OFFICIAL ACCESSORIES FOUND

NONE

PHOTO IDENTIFICATION DATA

Photo No. _____

Filed At. _____

Object Ident. _____

Ident. By _____

Signature _____

DESCRIBE CORNER LOCATION RELATIVE TO NEAR-BY FEATURES, ALSO HOW TO REACH CORNER

CORNER LEGEND:

FS or Unverified
Constr. Other

○ ◊ Searched For/Not Found

⊗ ⊗ Evidence Found/Accept.

● ◆ Permanent Mon. Set/Pd.

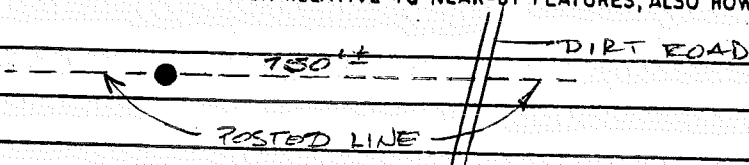

Searched By: Fred Ast

Title PLS

Division _____

Headquarters _____

Date

5/85

CORNER RECORD (PERPETUATION)

MONUMENT. DESCRIBE NEW MONUMENT SET, OR WORK DONE TO PRESERVE EXISTING MONUMENT

set 2 1/2" x 30" bed up. 2 sq. or 3' in stone mound
'single proportioned'

MONUMENT STAMPED

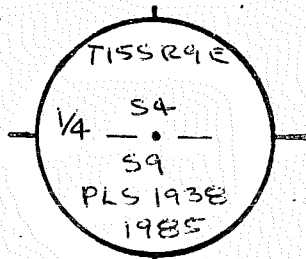

ACCESSORIES DESCRIBE NEW BT'S WITNESS OBJECTS ETC. ESTABLISHED, OR WORK DONE TO PRESERVE EXISTING EVIDENCE

scribed B.T.S

7" p. pine - N 24° W @ 43.70'

1/4 S4 BT

8" p. pine - S 81 1/2° E @ 67.51'

1/4 S9 BT

604 SPIKES w/ "PLS 1938" ALUM WASHERS DRIVEN INTO SIDES CENTER BASE

Work Done By Fred Ast

Title PLS

Date 5/85

State Registration No. 1938
or Agency

Is this Cor. Record Prepared? Yes

No

Filed At

Deer

Co. Surveyor's Office Date 6/85

History of Surveys, G.L.O., etc.

1870 - GLO - J. McCullough

Index File No. 1/55 T. 15 S., R. 9 E., W.M.

Contract or Surv. No 4-1

Cor. E/11

Index File No. 13/55 CORNER RECORD (SEARCH) Contract or Survey No. 4-1 Cor. No. E/13
 (Ref. FSM 7151.4) T 15 S. R. 9 E. R.D. Sisters County Deschutes S/E Cor. of
 Merid. Willamette N.F. Deschutes State Oregon Section 4

CORNER DIAGRAM per legend

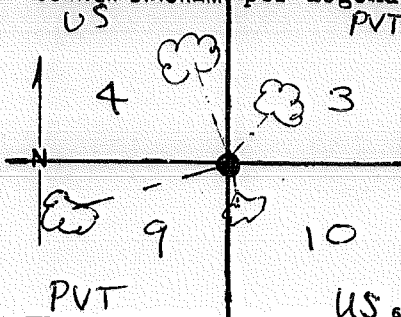

DESCRIBE CORNER MONUMENT FOUND

FND. 3 1/4" U.S. B.L.M. b.c.
 on 2 1/2" l.p. Rsg. 0.3' IN stn. md.

DESCRIBE BEARING TREES OR OTHER OFFICIAL ACCESSORIES FOUND

FND B.T.S. 8" p.pine N 22 W @ 85 LKS
 22" p.pine - S 75 1/2 W @ 194 LKS
 9" p.pine - S 6 1/4 E, @ 40 LKS
 20" p.pine - N 43 E, @ 50 LKS

PHOTO IDENTIFICATION DATA

Photo No. _____
 Filed At. _____
 Object Ident. _____
 Ident. By _____
 Signature _____

DESCRIBE CORNER LOCATION RELATIVE TO NEAR-BY FEATURES, ALSO HOW TO REACH CORNER

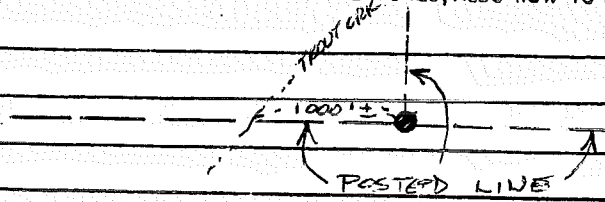

- CORNER LEGEND:
- FS or Unverified
 - Contr. Other
 - ◇ Searched For/Not Found
 - ⊗ ⊗ Evidence Found/Accept.
 - ◆ Permanent Mon. Set/Td.

Searched By: Fred Ast Title PLS Division _____ Headquarters _____ Date 5/85

CORNER RECORD (PERPETUATION)

MONUMENT. DESCRIBE NEW MONUMENT SET, OR WORK DONE TO PRESERVE EXISTING MONUMENT

MONUMENT STAMPED

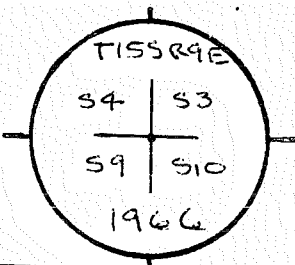

ACCESSORIES DESCRIBE NEW BT'S WITNESS OBJECTS ETC. ESTABLISHED, OR WORK DONE TO PRESERVE EXISTING EVIDENCE

9

10

11

12

13

Work Done By Fred Rst Title P.L.S. Date 5/85 State Registration No. 1938
 of Plat of or Agency
 Certified Cor Record Prepared? Yes No Filed At DuSard Co. Surveyor's Office Date 6/85

History of Surveys, G.L.O., etc.
1870 GLO BY J. McCLUNG

Index File No. 13/55 T. 15 S., R. 9 E., W.M.

Contract or Surv. No 4-1

Cor. E/13

LAND CORNER RECORD

5-15 5680-2

1. T 15S R 9E No. E-15 Cor. $\frac{1}{4}$ Mer. Will State Oregon (Rectangular) N. F. Deschutes Dist. Sisters

2. Corner Status

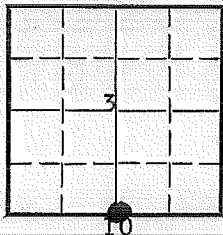

3. Original Description _____ Vol. _____ Page _____ Where Recorded _____

4. Description of Corners: 10-4-1870 13x12x10 for $\frac{1}{4}$ sec. cor.

5. Investigation Notes: No evidence.

*See Plat
(over)*

7. Photo Identification

Photo No. _____

Ident. By: _____

8. Plane Coordinate Position Data

State _____ Zone _____

X _____

Y _____

Estab. By _____

Field Book No. _____

Where Filed _____

9. Evaluation

Authentic _____

Needs Verif. _____ Monument _____

Re-estab. _____ Survey _____

Land Status _____

6. Signed *O. Tringvall* Title _____ Hwy. Eng. _____ Date 5-28-63

PERPETUATION RECORD

10. Monument: Set a 2" x 30" Gal Iron Pipe, 4" above the grd. w/ Brass Cap stamped as shown.

11. Accessories

- BT'S
1. A 4" P. Pine bears N67°E, 93 1/2' Dist.
 2. A 5" P. Pine bears S55°E, 75 1/2' Dist

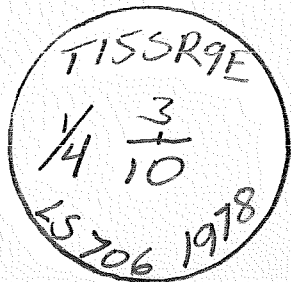

Field Book _____ Page _____

12. Set By Bruce Rogers Title Cad-Surveyor
 License LS 706 Agency USFS Date 3/78

13. Recorded By _____ Volume _____ Page _____
 (Agency) _____

 (Date) (City) (County) (State)

14. Remarks:

Index File No. 17/55

CORNER RECORD (SEARCH) Contract or

000754

T 15 S. R. 9 E. R.D. Sisters

(Ref. FSM 7151.4)

Survey No. 4-1

Cor. No. E/17

Merid. Willamette

N.F. Deschutes

County Deschutes

S/E Cor. of

State Oregon

Section 3

CORNER DIAGRAM per Legend

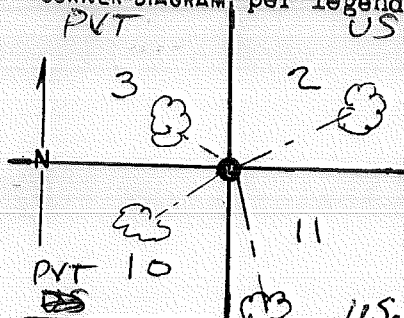

DESCRIBE CORNER MONUMENT FOUND

End $3\frac{1}{4}$ " U.S.B.L.M. b.c. on a $2\frac{1}{2}$ " I.P.
Rsg. 0.3' in stone mound

Fd as per record (Walt Miller - 1987)

DESCRIBE BEARING TREES OR OTHER OFFICIAL ACCESSORIES FOUND

End. B.T.'s: 21" p.pine - $N62\frac{1}{2}^{\circ}E$, 34 $\frac{1}{2}$ LKS.
11" p.pine - $57^{\circ}E$, 40 LKS.
7" p.pine - $N65^{\circ}W$, 13 $\frac{1}{2}$ LKS

Fd per record (Walt Miller - 1987)

DESCRIBE CORNER LOCATION RELATIVE TO NEAR-BY FEATURES, ALSO HOW TO REACH CORNER

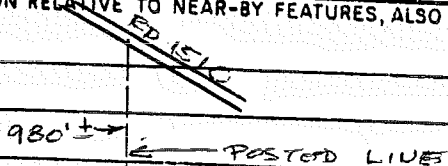

PHOTO IDENTIFICATION DATA

Photo No. _____
Filed At. _____
Object Ident. _____
Ident. By _____
Signature _____

CORNER LEGEND:

- | | | |
|--------|------------|------------------------|
| FS or | Unverified | |
| Contr. | Other | |
| ○ | ◇ | Searched For/Not Found |
| ⊗ | ⊗ | Evidence Found/Accept. |
| ● | ◆ | Permanent Mon. Set/Fd. |

Searched By: Fred Ast

Title PLS Division _____

Headquarters _____

Date 5/85

OWNER RECORD (PERPETUATION)

MONUMENT. DESCRIBE NEW MONUMENT SET, OR WORK DONE TO PRESERVE EXISTING MONUMENT

NONE RECD

MONUMENT STAMPEL

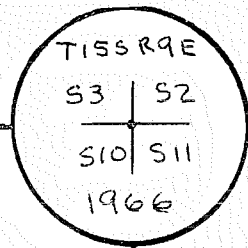

9

ACCESSORIES DESCRIBE NEW BT'S WITNESS OBJECTS ETC. ESTABLISHED, OR WORK DONE TO PRESERVE EXISTING EVIDENCE

NONE RECD

10

Work Done By Fred Ast Title P.C.S. Date 5/85 State Registration No. 1938
 or Agency

Flat of Certified for Record Prepared? Yes No Filed At Descal. Co. Surveyor's Office Date 6/85

11

History of Surveys, G.L.O., etc.
1870 GLO - J. McCune
1966 - B.L.M. REMONUMENTATION BY J.E. JERLEY
1978 - "OVERPASS SALE CADASTRAL" BY B. ROGERS

12

Index File No. 17/56 T.15 S., R. 9 E., W.M. Contract or Surv. No 4-1 Cor. E/17

13

LAND CORNER RECORD

(000130)

E-21 5680-2

1. T. 15S R. 9E No. E-21 Cor. Sec Mer. Will State ^(Rectangular) Oregon N. F. Deschutes Dist. Sisters

2. Corner Status

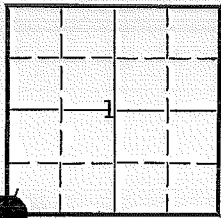

3. Original Description _____ Vol. _____ Page _____ Where Recorded _____

4. Description of Corners: 1870 Set stone 15x10x5 for cor to Secs 1, 2, 11, & 12 - from which a Pine 14 in. diam. bears S58°W, 18 lks. dist.

5. Investigation Notes: Found stone 17x8x8 ins above the ground in fair condition - no markings.

7. Photo Identification 7-14-59
Photo No. EG1-52-49
Ident. By: O. Thingvall

22" P. Pine ^{By BLM}
Blaze S60°W
healed 117'
over

20" PINE BLM S58°W 18 LKS

8. Plane Coordinate Position Data
State _____ Zone _____
X _____
Y _____
Etab. By _____
Field Book No. _____
Where Filed _____

From section line marker between sections 1 & 2 on Rd 1582 go south on old spur road to sign post that has "2B" on it. Just east is a yellow ribbon - a fence line - the section corner is approximately 420' north.
2" x 36" STEEL PIPE w/ 3" BRASS CAP SET AS INITIAL POINT FOR CROSSROADS THIRD ADDITION SUBDIVISION BY JAMES E. BOSSARD PLS OR-599 in 1974, PLAT Book 13, P. 37.

9. Evaluation
Authentic _____
Needs Verif. _____ Monument _____
Re-estab. _____ Survey _____
Land Status _____

6. Signed O. Thingvall Title _____ Hwy. Eng. _____ Date 5-28-63

PERPETUATION RECORD

10. Monument:

3" Brass Cap on 2 1/2" Steel Pipe

Per J. E. BUSSARD PCS-599 - 1972

11. Accessories

17" Pine, S42°E, 38 lks MKD T15S R9E S12 BT

11" Pine, N22°E, 43 lks MKD T15S R9E S1 BT

15" Pine, N35 1/2°W, 113 lks MKD T15S R9E S2 BT

Plus Old Ones

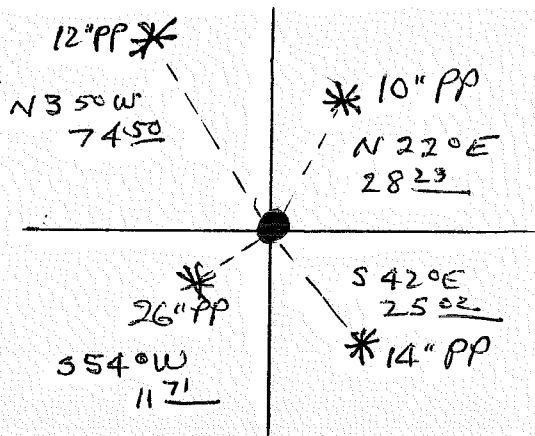

Field Book _____ Page _____

12. Set By _____ Title _____
 License _____ Agency BCM Date 1966

13. Recorded By _____ Volume _____ Page _____
 (Agency) _____
 (Date) _____ (City) _____ (County) _____ (State) _____

14. Remarks:

28 x 2 1/2" BCSP RSG 4"

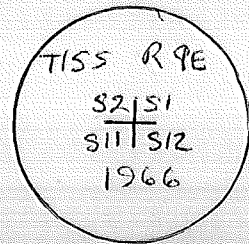

(PLAT #000130)

E-21

LAND CORNER RECORD

(000130)

E-23 5680-2

(Rectangular)

1. T 15S R 9E No. E-23 Cor. 1/4 Mer. Will State Oregon N. F. Deschutes Dist. Sisters

2. Corner Status

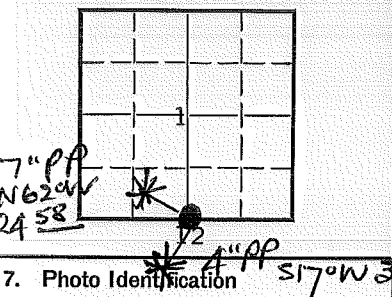

7. Photo Identification

Photo No. _____
Ident. By: _____

8. Plane Coordinate Position Data

State _____ Zone _____
X _____
Y _____
Establish. By _____
Field Book No. _____
Where Filed _____

9. Evaluation

Authentic _____
Needs Verif. _____ Monument _____
Re-estab. _____ Survey _____
Land Status _____

3. Original Description _____ Vol. _____ Page _____ Where Recorded _____

4. Description of Corners: 1870 Set stone 14x12x7 for 1/4 sec. cor.

5. Investigation Notes: At time of original survey, the surveyor failed to leave sufficient evidence for corner identification.

2 1/2" STEEL PIPE w/ 3" BRASS CAP SET AS POINT FOR CROSSROADS THIRD ADDITION SUBDIVISION BY JAMES E. BUSSARD, PLS OR-599 in 1974, PLAT BOOK 13, P. 27.

PPs: 4" PP S17°W 39.02 FT.
7" PP N62°W 24.58 FT.

6. Signed O. Ingrassia Title _____ Hwy. Eng. _____ Date 5-28-63

PERPETUATION RECORD

10. Monument:

11. Accessories

		Field Book _____	Page _____
12. Set By _____	Title _____	13. Recorded By _____	Volume _____
		(Agency)	Page _____
License _____	Agency _____	Date _____	(Date) _____
			(City) _____
			(County) _____
			(State) _____

14. Remarks:

(PLAT #000130)

LAND CORNER RECORD

(000130)

E-25 5680-2

1. T 15S R9E No. E-25 Cor. Sec. Mer. Will State Oregon (Rectangular) N. F. Deschutes Dist. Sisters

2. Corner Status

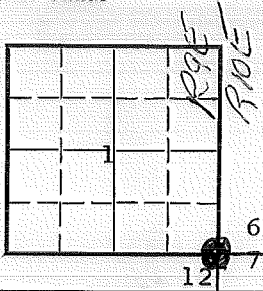

3. Original Description Vol. Page Where Recorded

4. Description of Corners: 1870 Set stone 18x15x10 for corner to Secs. 1, 6, 7, & 12 - from which a Pine 24 in. diam. bears S31°W, 25 lks. dist.

7. Photo Identification 7-14-63

Photo No. EG1-52-123

Ident. By: O. Thingvall

5. Investigation Notes: Found stone 18x10x10 ins. in poor condition with no markings.

18" P. Pine Snag (down)
Blaze on one side - no marks S36°W 17°

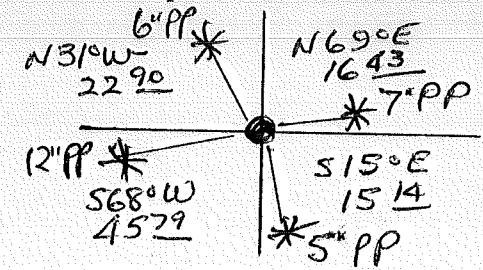

8. Plane Coordinate Position Data

State Zone

X

Y

Estab. By

Field Book No.

Where Filed

Section corner is 95' north of section line marker between sections 7 & 12 on Rd 1636.
2" x 36" STEEL PIPE w/ 3" BRASS CAP SET AS INITIAL POINT FOR CROSSROADS SECOND ADDITION SUBDIVISION BY JAMES E. BUSSARD PLS OR-599 in 1973, PLAT BOOK 12, P. 39.
000141 44K/ 3/80; B/S BTs

9. Evaluation

Authentic

Needs Verif. Monument

Re-estab. Survey

Land Status

6. Signed O. Thingvall Title Hwy. Eng. Date 5-28-63

PERPETUATION RECORD

10. Monument:

11. Accessories

		Field Book _____	Page _____
12. Set By _____	Title _____	13. Recorded By _____	Volume _____
License _____	Agency _____	(Agency)	Page _____
Date _____		(Date) _____	(City) _____
		(County) _____	(State) _____

14. Remarks:

USDA-FOREST SERVICE D-7100-52(2/82)

Index File No. 0151

CORNER RECORD (SEARCH)

(Ref. FSM 7151.4)

Contract or

Survey No.

Cor. No.

6-01

T 15 S. R. 9 E. R.D.

Sisters

County

Deschutes

W/4

Cor. of

Merid. Willamette

N.F.

Deschutes

State

Oregon

Section

7

CORNER DIAGRAM per legend

DESCRIBE CORNER MONUMENT FOUND

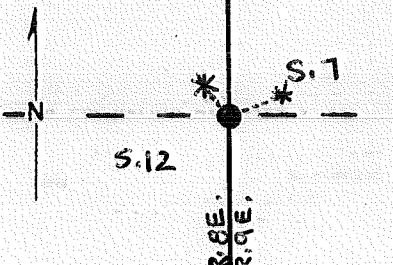

SFNF - AREA IS ON steep side slope and COVERED BY A THICK CARPET OF DUFF.

DESCRIBE BEARING TREES OR OTHER OFFICIAL ACCESSORIES FOUND

SFNF

PHOTO IDENTIFICATION DATA

Photo No. _____

Filed At. _____

Object Ident. _____

Ident. By _____

Signature

DESCRIBE CORNER LOCATION RELATIVE TO NEAR-BY FEATURES, ALSO HOW TO REACH CORNER

CORNER LEGEND:

- FS or Unverified
- Contr. Other
- Searched For/Not Found
- ◇ Searched For/Not Found
- ⊗ Evidence Found/Accept.
- ⊗ Evidence Found/Accept.
- Permanent Mon. Set/Pd.
- ◆ Permanent Mon. Set/Pd.

Searched By: N. Miller

Title PLS

Division CS

Headquarters SO

Date 6/86

CORNER RECORD (PERPETUATION)

MONUMENT STAMPED

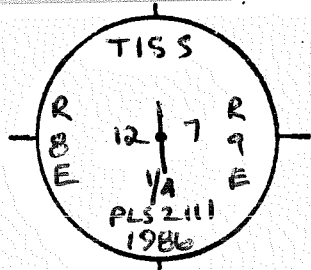

MONUMENT. DESCRIBE NEW MONUMENT SET, OR WORK DONE TO PRESERVE EXISTING MONUMENT

Set at the prorated position a 2 1/2" x 30" ACAP
Rising 15" in a Rock collar, MKD

ACCESSORIES DESCRIBE NEW BT'S WITNESS OBJECTS ETC. ESTABLISHED, OR WORK DONE TO PRESERVE EXISTING EVIDENCE

- 1) AN 8" W.F., BRS N33°W @ 10^{02'}, to a 60-d nail w/brass washer (LS 2111) IN the NE base, MKD 1/4 S 12 BT.
- 2) AN 8" W.F., BRS N68°E @ 5^{30'} FT, to a 60-d nail w/brass washer (LS 2111) in NW base, MKD 1/4 S 7 BT.

Work Done By W. Miller Title PLS Date 6/86 State Registration No. or Agency 2111

Plat or Record Prepared? Yes No Filed At Desch Co. Surveyor's Office Date 7/23/86

History of Surveys, G.L.O., etc. See plat No 000705

Index File No. 0157 T. 15 S., R. 9 E., W.M. Contract or Surv. No. Cor. G-01

LAND CORNER RECORD

(Rectangular)

G-5

5680-2

1. T 15S R 9E No. G-5 Cor. 1/4 Mer Will State Oregon N. F. Deschutes Dist. Sisters

2. Corner Status

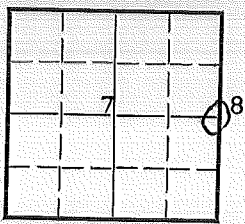

3. Original Description _____ Vol. _____ Page _____ Where Recorded _____

4. Description of Corners: 10-7-1870 Set stone 13x11x6 for 1/4 sec. cor.

5. Investigation Notes: At the time of the original survey, the surveyor failed to leave sufficient evidence for corner identification.

7. Photo Identification

Photo No. _____

Ident. By: _____

8. Plane Coordinate Position Data

State _____ Zone _____

X _____

Y _____

Estab. By _____

Field Book No. _____

Where Filed _____

9. Evaluation

Authentic _____

Needs Verif. _____ Monument _____

Re-estab. _____ Survey _____

Land Status _____

6. Signed C. Thungrall Title Hwy. Eng. Date 5-28-63

PERPETUATION RECORD

10. Monument:

11. Accessories

12. Set By _____ Title _____	Field Book _____ Page _____
License _____ Agency _____ Date _____	13. Recorded By _____ Volume _____ Page _____ (Agency)
	(Date) (City) (County) (State)

14. Remarks:

USDA-FOREST SERVICE D-7100-52(2/82)

Index

File No. 9/57

CORNER RECORD (SEARCH) Contract or

(Ref. FSM 7151.4)

Survey No. 4-1

Cor. No. G/g

T 15 S. R. 9 E.

R.D. Sisters

County Deschutes

1/4

Cor. of

Merid. Willamette

N.F. Deschutes

State Oregon

Sections E&G

CORNER DIAGRAM

per legend

DESCRIBE CORNER MONUMENT FOUND

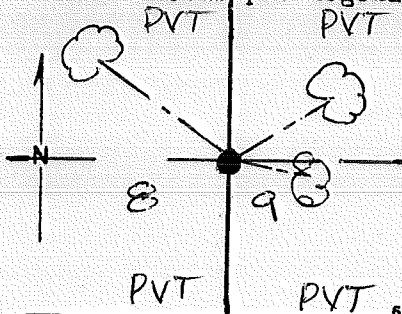

END. orig. stn. - 18" X 10" X 10"

with "4" on face

DESCRIBE BEARING TREES OR OTHER OFFICIAL ACCESSORIES FOUND

END. 36" p.p. pins with open face

& scribed AK facing corner (S84°E, 15.0')
orig. w/ g UNKNOWN

PHOTO IDENTIFICATION DATA

Photo No. _____

Filed At. _____

Object Ident. _____

Ident. By _____

Signature

7

DESCRIBE CORNER LOCATION RELATIVE TO NEAR-BY FEATURES, ALSO HOW TO REACH CORNER

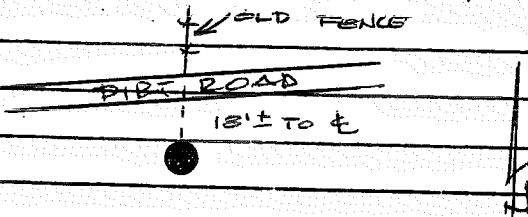

CORNER LEGEND:

FS or Unverified

Contr. Other



Searched For/Not Found



Evidence Found/Accept.



Permanent Mon. Set/Fd.

Searched By: Fred Ast

Title PLS Division

Headquarters

Date 5/85

CORNER RECORD (PERPETUATION)

MONUMENT. DESCRIBE NEW MONUMENT SET, OR WORK DONE TO PRESERVE EXISTING MONUMENT

set 2 1/2" x 30" b.c.d. i.p. R.S.B. 0.6' ABOVE GROUND

MONUMENT STAMPED

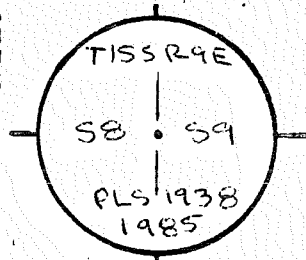

ACCESSORIES DESCRIBE NEW BT'S WITNESS OBJECTS ETC. ESTABLISHED, OR WORK DONE TO PRESERVE EXISTING EVIDENCE

Scribed B.T.S.

10" W. FIR N 50 1/2° W @ 48 54

1/4 58 BT

6" W. FIR N 57 1/2° E @ 28 53

1/4 59 BT

Good SPIKE w/ "PLS 1938" ALUM. WAS HERE DELIVERED INTO SIDE CENTER BASE

Work Done By Fred Ast Title p.c.s.

Date 5/85 State Registration No. 1938 or Agency

Plat or Cor Record Prepared? (Yes)

No Filed At Desch Co. Surveyor's Office Date

History of Surveys, G.L.O., etc. 1870 - G.L.O. - J. McCulla

Index File No. 9/57 T. 15S., R. 9 E., W.M.

Contract or Surv. No 4-1

Cor. 6/9

LAND CORNER RECORD

(Rectangular)

G-13 5680-2

1. T 15 S. R 9 E., No. G-13 Cor. $\frac{1}{4}$ Mer. Will State Oregon N. F. Deschutes Dist. Sisters

2. Corner Status

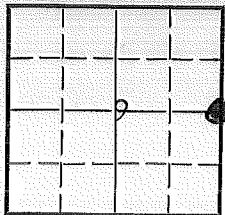

3. Original Description _____ Vol. _____ Page _____ Where Recorded _____

4. Description of Corners: 10-4-1870 Set stone 14+14+10 for $\frac{1}{4}$ Sec cor.

5. Investigation Notes: At time of original survey, the surveyor failed to leave sufficient evidence for corner identification.

*See Plat
(over)*

7. Photo Identification

Photo No. _____
Ident. By: _____

8. Plane Coordinate Position Data

State _____ Zone _____
X _____
Y _____
Etab. By _____
Field Book No. _____
Where Filed _____

9. Evaluation

Authentic _____
Needs Verif. _____ Monument _____
Re-estab. _____ Survey _____
Land Status _____

6. Signed C. Tringali Title Hwy Eng Date 6-11-63

PERPETUATION RECORD

10. Monument: Set a 2"x30" Gal. Iron Pipe, 4" above the grd. w/ Brass Cap Stamped as shown.



11. Accessories

BT's
 1. A 8" P. Pine bears N83°W, 110±' Dist.
 2. A 9" Fir bears N 45°W, 91±' Dist.

		Field Book _____	Page _____
12. Set By <u>Bruce Rogers</u> Title <u>Cad-Surveyor</u>		13. Recorded By _____	Volume _____
License <u>LS 706</u> Agency <u>USFS</u> Date <u>3/78</u>		(Agency)	Page _____
		(Date) _____	(City) _____
		(County) _____	(State) _____

14. Remarks:

Index

File No. 1757

T 15 S R. 9 E.

Mer id. WM

CORNER RECORD (SEARCH)

(Ref. FSM 7151.4)

R.D. Sisters

N.F. DNF

County Deschutes

State OR

Tract or Survey No.

000754

Cor. No. G-17

W/4 cor.

Sec. 11

CORNER DIAGRAM

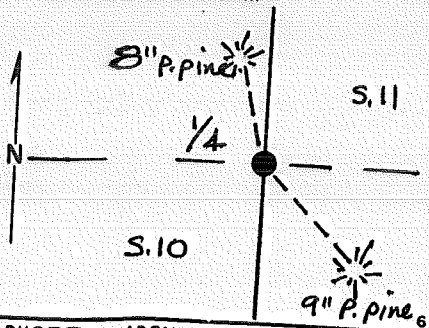

DESCRIBE CORNER MONUMENT FOUND

SF/NF

DESCRIBE BEARING TREES OR OTHER OFFICIAL ACCESSORIES FOUND

SF/NF

PHOTO IDENTIFICATION DATA

Photo No. _____

Filed At _____

Object Ident. _____

Ident. By _____

Signature

7

PLANE COORDINATE POSITION DATA

State _____ Zone _____

X _____

Y _____

Estab. By _____

Agency

8

DESCRIBE CORNER LOCATION RELATIVE TO NEAR-BY FEATURES, ALSO HOW TO REACH CORNER

3

Signature
Walt Miller

Title
PLS

Division
CS

Headquarters
SO

Date
8/87

7100-52-(3/68)

4

5

CORNER RECORD (PERPETUATION)

MONUMENT: DESCRIBE NEW MONUMENT SET, OR WORK DONE TO PRESERVE EXISTING MONUMENT

Set from survey a 2 1/2" x 30" BCSP Rising 6" in stone mound.

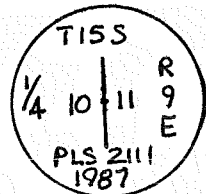

ACCESSORIES: DESCRIBE NEW BT'S WITNESS OBJECTS ETC. ESTABLISHED, OR WORK DONE TO PRESERVE EXISTING EVIDENCE

- 1) An 8" P. pine bears N 08° 58' W @ 14.0 ft, to a 60-d spike in West base, MARKED 1/4 S10 BT.
- 2) A 9" P. pine bears S 45° 02' E @ 25.9 ft, to a 60d spike in NE base, MARKED 1/4 S11 BT.

Work Done By W. Miller Title PLS Date 8/87 State Registration No. 2111
 Certified Cor. Record Prepared? No Filed At: Deschutes Co. or Agency Date 9/18/87

REMARKS

Index File No.

1757

T.

R.

M.

Tract or Surv. No.

Cor.

6-17

USDA-FOREST SERVICE

Index
File No. 2157

T 153 R. 9E

Merid. WM

CORNER RECORD (SEARCH)

(Ref. FSM 7151.4)

53-0466-3-02829

Tract or

Survey No.

Cor.

No. 9-21

R.D. SISTERS County DESCHUTES

N.F. DESCHUTES State OREGON

E 1/4 COR. OF

SEC. 11

CORNER DIAGRAM

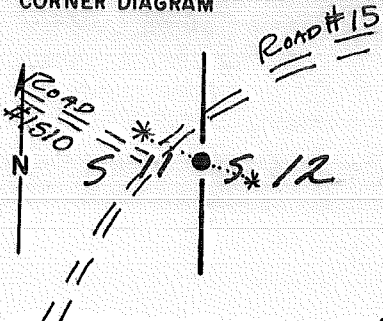

DESCRIBE CORNER MONUMENT FOUND

NONE

DESCRIBE BEARING TREES OR OTHER OFFICIAL ACCESSORIES FOUND

NONE

PHOTO IDENTIFICATION DATA

Photo No. _____

Filed At. _____

Object Ident. _____

Ident. By _____

Signature

PLANE COORDINATE POSITION DATA

State _____ Zone _____

X _____

Y _____

Estab. By _____

Agency

Signature

RCC

Title

PLS 1632

Division

+

Headquarters

Date

6/84

7100-52-(3/68)

5

T
CORNER RECORD (PERPETUATION)

MONUMENT: DESCRIBE NEW MONUMENT SET, OR WORK DONE TO PRESERVE EXISTING MONUMENT

SET STANDARD USFS 2 1/2" X 30" GALV. PIPE BRASS
CAP MONUMENT ~~ON SOLID ROCK~~ ON SOLID ROCK.
EJECTED STONE MOUND AROUND MONUMENT RISING 2'
FILLED WITH SMALL STONES AND DIRT TO
HOLD MONUMENT FIRMLY IN PLACE, 3 1/2" Ø.
MONUMENT RISES 5" ABOVE MOUND

T155 29B
 1/4
 |
 511.512
 1984
 PLS 1632

ACCESSORIES: DESCRIBE NEW BT'S WITNESS OBJECTS ETC. ESTABLISHED, OR WORK DONE TO PRESERVE EXISTING EVIDENCE

A 11" DBH P. PINE BEARS N37°30'W, 115.89 FT. SCRIBED 1/4, 511, BT
 A 13" DBH P. PINE BEARS ^S83°E, 23.56 FT. SCRIBED 1/4, 512, BT.

10

Work Done By RCC Title PLS Date 6/84 State Registration No. 1632, OR.
 or Agency

Certified Cor. Record Prepared? Yes No Filed At: DES. CO. SURV. OFFICE Date 26 JUNE 1984 11

REMARKS

J. H. McCUNG SET 2 1/2" X 30" STONE
 No BTs.

12

53-0496-3-02827

Index File No. 2157 T. 155 R. 9E M. WM Tract or Surv. No. 6-21 Cor. 13
 U.S. G.P.O. 1977-725-576/586

Index
File No. _____
T 155 R. R9E
Merid. Will

CORNER RECORD (SEARCH)

(Ref. FSM 7151.4)

R.D. Sisters County Deschutes
N.F. Deschutes State Oregon

Tract or
Survey No. _____
Cor.
No. G-25

CORNER DIAGRAM

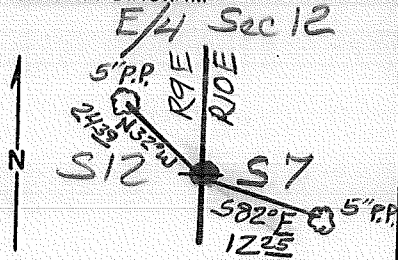

DESCRIBE CORNER MONUMENT FOUND

Set #5 Steel Rod w/ Plastic Cap
by James E Bussard PLS. 599
in 1972

DESCRIBE BEARING TREES OR OTHER OFFICIAL ACCESSORIES FOUND

6

PHOTO IDENTIFICATION DATA

Photo No. _____
Filed At. _____
Object Ident. _____
Ident. By _____

Signature

7

DESCRIBE CORNER LOCATION RELATIVE TO NEAR-BY FEATURES, ALSO HOW TO REACH CORNER

PLANE COORDINATE POSITION DATA

State _____ Zone _____
X _____
Y _____
Estab. By _____
Agency

8

Signature Dan Sanbwich Title Survey Tech Division Eng. Headquarters SO Date 8/78 7100-52 (3 68)

4

5

CORNER RECORD (PERPETUATION)

MONUMENT
STAMPED:

MONUMENT: DESCRIBE NEW MONUMENT SET, OR WORK DONE TO PRESERVE EXISTING MONUMENT

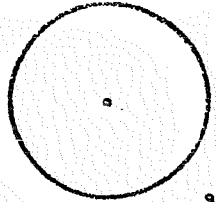

9

ACCESSORIES : DESCRIBE NEW BT's WITNESS OBJECTS ETC. ESTABLISHED, OR WORK DONE TO PRESERVE EXISTING EVIDENCE

10

Work Done By _____ Title _____ Date _____ State Registration No.
or Agency _____

Certified Cor. Record Prepared? Yes No Filed At: _____ Date _____

11

REMARKS

12

Index File No. T. R. M. Tract or Surv. No. Cor. **6-25**

13

LAND CORNER RECORD

(Rectangular)

J-1 5680-2

1. T 15S R 9E No. J-1 Cor. Sec. Mer Will State Oregon N. F. Deschutes Dist. Sisters

2. Corner Status

3. Original Description _____ Vol. _____ Page _____ Where Recorded _____

4. Description of Corners: 9-29-1870 Set stone 18x15x8 for cor. to secs. 7, 12, 13, & 18

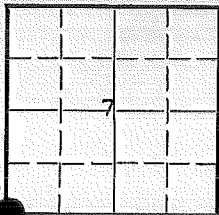

5. Investigation Notes: Found a stone 12x8x11 ins. above the ground in poor condition with no markings. B-S, Inc. section corner tag states "Approx cor"

7. Photo Identification

FD. STONE AS STATED. FOUND LINE TREES EAST AND SOUTH. *R* 8/79

Photo No. _____

Ident. By: _____

8. Plane Coordinate Position Data

State _____ Zone _____

X _____

Y _____

Estab. By _____

Field Book No. _____

Where Filed _____

9. Evaluation

Authentic _____

Needs Verif. _____ Monument _____

Re-estab. _____ Survey _____

Land Status _____

S. CHAMBERLAIN 8-17-83

6. Signed D. Ingvall Title _____ Hwy. Eng. _____ Date 6-4-63

PERPETUATION RECORD

10. Monument:

SET 2 1/2" X 32" BRASS-CAPPED STEEL PIPE RISING 4"
FROM LINE TREES & STONE

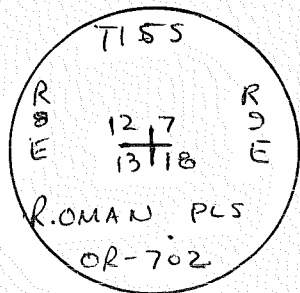

11. Accessories

- 9" WHITE FIR BRS. N82°W 20° FT. MKD. "T155, R8E, S12, BT"
- 8" " " " N30°E 25° FT. " "T155 R9E S7 BT"
- 7" " " " S20°E 9° FT. " "T155 R9E S18 BT"
- 8" " " " S40°W 9° FT. " "T155 R8E S13 BT"

Field Book _____ Page _____

12. Set By R.OMAN Title PLS
License OR-702 Agency _____ Date 8/79

13. Recorded By _____ Volume _____ Page _____
(Date) (City) (Agency) DESCHUTES OREGON
(County) (State)

14. Remarks:

Revisited By W. Miller (PLS 2111) 6/86
See plat No 000705

USDA-FOREST SERVICE

Index File No. 0359

CORNER RECORD (SEARCH)

(Ref. FSM 7.151.4)

Tract or Survey No. _____

Cor. No. J-3

T. 15 S. R. 9

E. R.D. Sisters County Deschutes

N/4 COR. of SEC. 18

Merid. WILLAMETTE

N.F. DESCHUTES State OREGON

COR. of SEC. _____

CORNER DIAGRAM PER LEGEND

DESCRIBE CORNER MONUMENT FOUND

Nothing found

DESCRIBE BEARING TREES OR OTHER OFFICIAL ACCESSORIES FOUND

None

DESCRIBE CORNER LOCATION RELATIVE TO NEAR-BY FEATURES, ALSO HOW TO REACH CORNER

Take USFS Rd#1535S to Rd#1502. Turn right for 1.7 miles to Rd#1502-D. Turn right for 0.4 mile. Stop, walk 700' east to corner.

PHOTO IDENTIFICATION DATA

Photo No. _____

Filed At. _____

Object Ident. _____

Ident. By _____

Signature _____

Corner Legend:

Searched for/Not Found

Evidence Found/Accept

Permanent Monument

Signature Edgar Swave

Title

Surveyor

Division

ORLS 980

Headquarters

Bend

Date

12/80

D-7100-52 (3/79)

CORNER RECORD (PERPETUATION)

MONUMENT DESCRIBE NEW MONUMENT SET, OR WORK DONE TO PRESERVE EXISTING MONUMENT

Set 2½" Aluminum cap on 2½"X30" Aluminum pipe, 16" in ground with mound of stone to cap.

MONUMENT SET

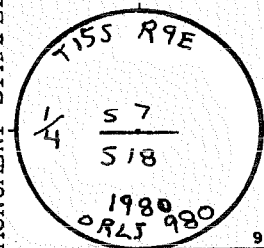

ACCESSORIES DESCRIBE NEW B.T.'s WITNESS OBJECTS ETC. ESTABLISHED, OR WORK DONE TO PRESERVE EXISTING EVIDENCE

10" Fir, N20°E, 25.2', Scribed 1/4 S7 B.T.
 6" Fir, S15½°W, 8.3', Scribed 1/4 S18 B.T.
 All B.T.'s have sign 54-4 & 54-3 attached. Set polymer post with 54-4 sign and 54-2a decal, 4' east of monument. Painted red band around bearing trees. Tagged trees w/L.S. 980 washer.

Work Done By E.W. Graves Title Surveyor Date 12/80 State Registration No. ORLS 980
 or Agency

PLAT PREPARED OR
 Certified Cor. Record Prepared? Yes No Filed At: Deschutes Co. SURVEYOR'S OFFICE Date

REMARKS

Witnesses to the above corner: D. Scott
 R. Taylor

Index File No. 0359 T. 15 S., R. 9 E., W.M. Tract or Surv. No. Cor. J-3

LAND CORNER RECORD

J-5 5680-2

(Rectangular)

1. T 15S R 9E No. J-5 Cor. Sec. Mer. Will State Oregon N. F. Deschutes Dist. Sisters

2. Corner Status

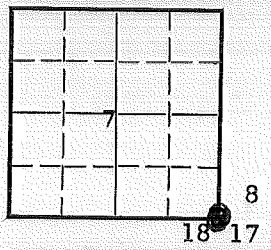

3. Original Description _____ Vol. _____ Page _____ Where Recorded _____

4. Description of Corners: 10-7-1870 Set stone 16x11x6 for cor. to secs. 7, 8, 17 & 18 - from which a Pine 20 ins. dia. bears S45°W, 3 lks. dist.

5. Investigation Notes: Found a stone 7x11x12 ins. above the ground in good condition with no markings.

7. Photo Identification 7-14-59'

Photo No. EG1-51-3

Ident. By: O. Thingvall

26" P, Pine



S42°W
20'

8. Plane Coordinate Position Data

State _____ Zone _____

X _____

Y _____

Estab. By _____

Field Book No. _____

Where Filed _____

Section corner is 290' east of section line marker between sections 7 & 18 on Rd. 15022-A.

9. Evaluation

Authentic _____

Needs Verif. _____ Monument _____

Re-estab. _____ Survey _____

Land Status _____

6. Signed O. Thingvall Title _____ Hwy. Eng. _____ Date 6-4-63

PERPETUATION RECORD

10. Monument:

Brass Cap on 2 1/2" x 28" S. PIPE RSG. 4"

TISS R9E
S7 | S8
S18 | S17
1966

11. Accessories

6" ^WFir, N79°E, 62 lks MKD TISS R9E S8 BT
 9" ^WFir, S56 1/2°E, 80 lks " TISS R9E S17 BT
 6" ^WFir, S11°W, 52 1/2 lks " TISS R9E S18 BT
 12" ^WFir, N71°W, 32 lks " TISS R9E S7 BT

Plus Old Ones

Field Book _____ Page _____

12. Set By _____ Title _____

License _____ Agency BLM Date 1966

13. Recorded By _____ Volume _____ Page _____

(Agency)

(Date) _____ (City) _____ (County) _____ (State) _____

14. Remarks:

BT'S OK 7/79 ^{lks}
 NEEDS GUARD POST AT MONUMENT

USDA-FOREST SERVICE

Index
File No. 0759

CORNER RECORD (SEARCH)

(Ref. FSM 7.151.4)

Tract or
Survey No. _____

Cor. J-7
No. _____

T. 15 S. R. 9

E. R.D. Sisters

County Deschutes

N/4 COR. of SEC. 17

Merid. WILLAMETTE

N.F. DESCHUTES

State OREGON

COR. of SEC. _____

CORNER DIAGRAM PER LEGEND

DESCRIBE CORNER MONUMENT FOUND

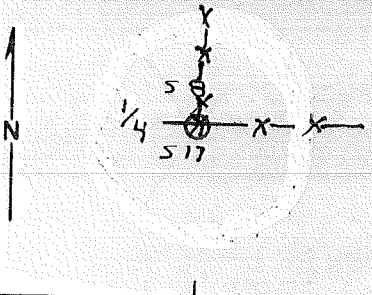

Nothing found

DESCRIBE BEARING TREES OR OTHER OFFICIAL ACCESSORIES FOUND

none

PHOTO IDENTIFICATION DATA

Photo No. _____

Filed At. _____

Object Ident. _____

Ident. By _____

Signature

DESCRIBE CORNER LOCATION RELATIVE TO NEAR-BY FEATURES, ALSO HOW TO REACH CORNER

Take USFS Rd#1535S for 2.5 miles to wood post and location poster. Stop, walk 1100' east across Trout Creek to corner.

Corner Legend:

Searched for/Not Found

Evidence Found/Accept.

Permanent Monument

Signature
Edgar Gaves

Title
Surveyor

Division
ORLS 980

Headquarters
Bend

Date
12/80

D-7100-52 (3/79)

CORNER RECORD (PERPETUATION)

MONUMENT DESCRIBE NEW MONUMENT SET, OR WORK DONE TO PRESERVE EXISTING MONUMENT

Set 2½" Aluminum cap on 2½"X30" Aluminum pipe 24" in ground with mound of stone to cap.

MONUMENT STARTED

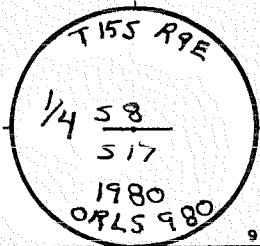

ACCESSORIES DESCRIBE NEW B.T.'s WITNESS OBJECTS ETC. ESTABLISHED, OR WORK DONE TO PRESERVE EXISTING EVIDENCE

6" Fir, S11½°W, 6.9', Scribed 1/4 S17, B.T.
 10" Fir, N82°W, 13.4', Scribed 1/4 S8, B.T.
 All B.T.'s have sign 54-4 & 54-3 attached. Set polymer post with 54-4 sign and 54-2a decal, 3' east of monument. Painted red band around bearing trees. Tagged trees w/L.S. 980 washer.

10

Work Done By E.W. Graves Title Surveyor Date 12/80 State Registration No. ORLS 980
 or Agency

PLAT PREPARED OR
 Certified Cor. Record Prepared? Yes No Filed At: Deschutes Co. SURVEYOR'S OFFICE Date

11

REMARKS

Witnesses to the above corner: D. Scott
 R. Larson

Index File No. 0759 T. 15 S., R. 9 E., W.M. Tract or Surv. No. Cor. J-7

12

13

Index

File No. 9/59

CORNER RECORD (SEARCH) Contract or

(Ref. FSM 7151.4)

Survey No. 4-1

Cor. No. J/9

T 15 S. R. 9 E. R.D. Sisters

County Deschutes

S/E Cor. of

Merid. Willamette

N.F. Deschutes

State Oregon

Section 8

CORNER DIAGRAM per Legend

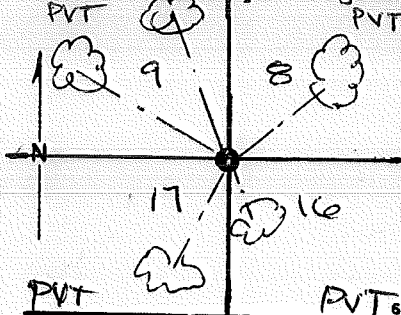

DESCRIBE CORNER MONUMENT FOUND

FND 3 1/2" U.S. B.L.M. b.c. on 2 1/2" i.p.
Rsg. 0.3 & 1.5' N/E of a N-E FNC. cor.

DESCRIBE BEARING TREES OR OTHER OFFICIAL ACCESSORIES FOUND

B.T. 36" P. Pine N14°W @ 60 LKS (orig.)
B.T. 12" P. Pine N51°E @ 57 1/2 LKS
B.T. 9" P. Pine S21°E @ 7 1/2 LKS

14" P. Pine S19°W @ 52 1/2 LKS

10" P. Pine N54°W @ 60 LKS

PHOTO IDENTIFICATION DATA

Photo No. _____

Filed At. _____

Object Ident. _____

Ident. By _____

Signature

7

DESCRIBE CORNER LOCATION RELATIVE TO NEAR-BY FEATURES, ALSO HOW TO REACH CORNER

DIRT ROAD

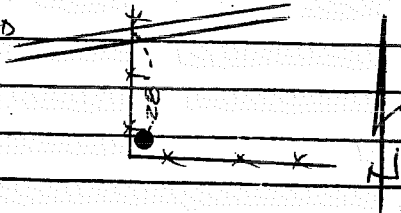

CORNER LEGEND:

FS or Unverified
Costr. Other

○ ◇ Searched For/Not Found

⊗ ⊗ Evidence Found/Accept.

● ◆ Permanent Mon. Set/Pd.

Searched By: Fred Ast

Title

PLS

Division

Headquarters

Date

5/85

CORNER RECORD (PERPETUATION)

MONUMENT. DESCRIBE NEW MONUMENT SET, OR WORK DONE TO PRESERVE EXISTING MONUMENT

NONE RECD

MONUMENT STAMPED

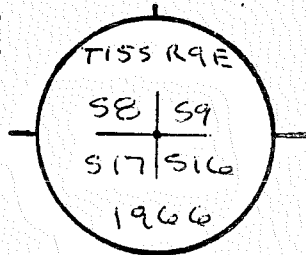

ACCESSORIES DESCRIBE NEW BT'S WITNESS OBJECTS ETC. ESTABLISHED, OR WORK DONE TO PRESERVE EXISTING EVIDENCE

NONE RECD

Work Done By Fred Ast Title PLS Date 5/85 State Registration No. 1938
or Agency

Certified Cor Record Prepared? Yes No Filed At Desch Co. Surveyor's Office Date 6/85

History of Surveys, G.L.O., etc. 1870-GLO-J. McCullong

Index File No. 2/59 T. 15 S., R. 9 E., W.M. Contract or Surv. No 4-1 Cor J/9

USDA-FOREST SERVICE

Index

File No. 1159

T. 15 S. R. 9 E.

Merid. WILLAMETTE

CORNER RECORD (SEARCH)

(Ref. FSM 7.151.4)

R.D. Sisters

N.F. DESCHUTES

County Deschutes

State OREGON

Tract or

Survey No. _____

Cor.

No. J-11

1/4 COR. of SEC. 16

COR. of SEC. _____

CORNER DIAGRAM PER LEGEND

DESCRIBE CORNER MONUMENT FOUND

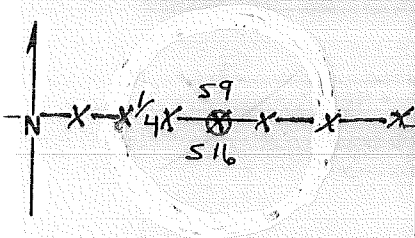

Nothing found

DESCRIBE BEARING TREES OR OTHER OFFICIAL ACCESSORIES FOUND

None

PHOTO IDENTIFICATION DATA

Photo No. _____

Filed At. _____

Object Ident. _____

Ident. By _____

Signature

DESCRIBE CORNER LOCATION RELATIVE TO NEAR-BY FEATURES, ALSO HOW TO REACH CORNER

Take USFS Rd#1536 to Rd#1536-A. Go 2.7 miles to FR-43, turn right for 0.25 mile. Stop, walk north to fence. Corner located on west of gully.

Corner Legend:

Searched for/Not Found

Evidence Found/Accept.

Permanent Monument

Signature
Edgar Swales

Title

Surveyor

Division

ORLS 980

Headquarters

Bend

Date

12/80

D-7100-52 (3/79)

CORNER RECORD (PERPETUATION)

MONUMENT DESCRIBE NEW MONUMENT SET, OR WORK DONE TO PRESERVE EXISTING MONUMENT

Set 2 1/2" Aluminum cap on 2 1/2"X30" Aluminum pipe 26" in ground with mound of stone to cap.

MONUMENT SET/STAMPED

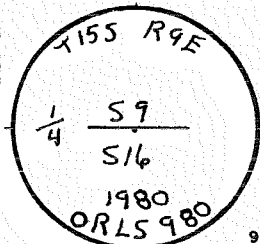

ACCESSORIES DESCRIBE NEW BT'S WITNESS OBJECTS ETC. ESTABLISHED, OR WORK DONE TO PRESERVE EXISTING EVIDENCE

8" P.Pine, N70 1/2°W, 36.3', Scribed S1/4 S9 B.T.
 6" P.Pine, S74°E, 47.7', Scribed N1/4 S16 B.T.
 All B.T.'s have sign 54-4 & 54-3 attached. Set polymer post with 54-4 sign and 54-2a decal. Painted red band around bearing trees. Tagged trees w/L.S. 980 washer.

Work Done By E.W. Graves Title Surveyor Date 12/80 State Registration No. ORLS 980
 or Agency
PLAT PREPARED OR
 Certified Cor Record Prepared? Yes No Filed At: Deschutes Co. SURVEYOR'S OFFICE Date

REMARKS

Witnesses to the above corner: D. Scott
 R. Larson

Index File No. 1159 T. S., R. E., W. M. Tract or Surv. No. Cor. J-11

LAND CORNER RECORD

J-13 5680-2

(Rectangular)

1. T15S R 9E No. J-13 Cor. Sec. Mer. Will State Oregon N. F. Deschutes Dist. Sisters

2. Corner Status

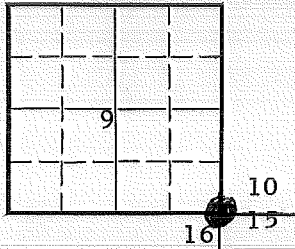

3. Original Description Vol. Page Where Recorded

4. Description of Corners: 10-4-1870 Set stone 14x8x5 for cor. to secs. 9, 10, 15 & 16 from which a Pine 24 in. diam. bears N53 1/2°E, 24 lks. dist.

5. Investigation Notes: Found stone 8x6x8 ins. above the ground in good condition with no markings.

7. Photo Identification 7-14-59

Photo No. EG1-51-119
Ident. By: O. Thingvall

33" P. Pine

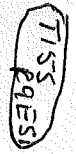

N57°E
16'

OK still standing 7/79 Kwo

8. Plane Coordinate Position Data

State Zone
X
Y
Estab. By
Field Book No.
Where Filed

Approximately 250' ^{NORTH} ~~east~~ of section line marker between sections 15 & 16 on Rd 1536-A there is a road to the N. Follow this to fence - corner is about 50' north.

ABOUT 50' North of Gate on Spur Road and about 250' North of 1536 A

9. Evaluation

Authentic
Needs Verif. Monument
Re-estab. Survey
Land Status

6. Signed O. Thingvall Title Hwy. Eng. Date 5-28-63

PERPETUATION RECORD

10. Monument:

Brass Cap on 2 1/2" x 28" S. PIPE RSG. 4"
in MD. of STONES 2' at Base

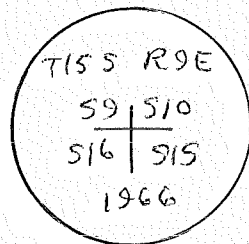

11. Accessories

11" Pine, N35°E, 83 lks MKD T155 R9E S10 BT
 10" Pine, N26 1/2°W, 105 1/2 lks " T155 R9E S9 BT
 13" Pine, S81E, 71 lks " T155 R9E S15 BT
 6'x6'x6' Rock Above Ground with X on North Side, S34 1/2°W, 103 lks MKD " X B0 "
 Plus Old Ones ^{along south side of Spur Road.}

Field Book _____ Page _____

12. Set By _____ Title _____
 License _____ Agency BLM Date 1966

13. Recorded By _____ Volume _____ Page _____
 (Agency)

 (Date) (City) (County) (State)

14. Remarks:

BT's OK 8/79 /uo

LAND CORNER RECORD

J-15 5680-2

(Rectangular)

1. T15S R9E No. J-15 Cor. 4 Mer. Will State Oregon N. F. Deschutes Dist. Sisters

2. Corner Status

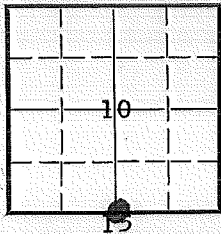

3. Original Description Vol. Page Where Recorded

4. Description of Corners: 10-4-1870 Set stone 14x12x7 for 1/4 sec. cor.

5. Investigation Notes: At time of original survey, the surveyor failed to leave sufficient evidence for corner identification.

see Plat
(over)

Cor. OK 8/79 P. De SANTIS

7. Photo Identification

Photo No. _____

Ident. By: _____

8. Plane Coordinate Position Data

State _____ Zone _____

X _____

Y _____

Estab. By _____

Field Book No. _____

Where Filed _____

9. Evaluation

Authentic _____

Needs Verif. _____ Monument _____

Re-estab. _____ Survey _____

Land Status _____

6. Signed O. Tringali Title Hwy. Eng. Date 5-28-63

PERPETUATION RECORD

10. Monument: Set a 2" x 30" Gal. Iron Pipe, 5" above the grd. w/Bros Cap Stamped as shown.

11. Accessories

B.T.'s

1. A 12" P. Pine bears S44°E, 324' Dist.
2. A 5" P. Pine bears S23°W, 30' Dist.

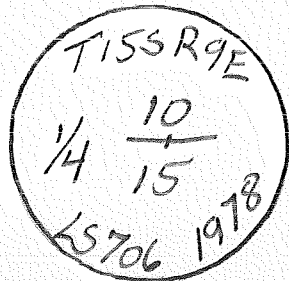

Field Book _____ Page _____

12. Set By Bruce Rogers Title Cad. - Surveyor
 License LS 706 Agency USFS Date 3/78

13. Recorded By _____ Volume _____ Page _____
 (Agency)

 (Date) (City) (County) (State)

14. Remarks:

Index

File No. J 17

CORNER RECORD (SEARCH)

(Ref. FSM 7151.4)

Tract or Survey No. 000754

Cor. No. J-17

T 155 R. 9E

R.D. 5 County DES

Merid. Will

N.F. DES State OR

CORNER DIAGRAM

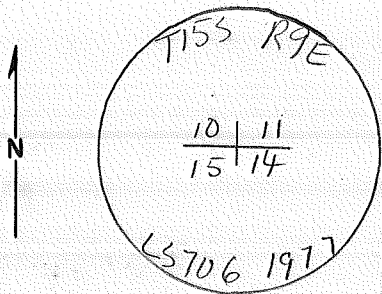

DESCRIBE CORNER MONUMENT FOUND

Stone 15" x 12" x 8"

W. Miller found BCSP (8/87)

DESCRIBE BEARING TREES OR OTHER OFFICIAL ACCESSORIES FOUND

48" Pine N 32 1/2° W 28³⁸'

PHOTO IDENTIFICATION DATA

Photo No. _____

Filed At. _____

Object Ident. _____

Ident. By _____

Signature

PLANE COORDINATE POSITION DATA

State _____ Zone _____

X _____

Y _____

Estab. By _____

Agency

Signature

Title

Division

Headquarters

Date

7100-52 (3, 68)

CORNER RECORD (PERPETUATION)

MONUMENT: DESCRIBE NEW MONUMENT SET, OR WORK DONE TO PRESERVE EXISTING MONUMENT

Pipe & Cap Rsg. 6" in Md. of Stones

9

ACCESSORIES: DESCRIBE NEW BT'S WITNESS OBJECTS ETC. ESTABLISHED, OR WORK DONE TO PRESERVE EXISTING EVIDENCE

8" P. Pine N31°W 20' ✓

6" P. Pine N57°E 37' ✓

6" P. Pine S59°E 57' ✓

(Arce down) 4" P. Pine S69°W 27' replaced with an 8" p. pine br. S89°W @47.25' in 1987 to a spike IN N base, MKD TISSR9ESISBT

10

Work Done By B. Rogers Title Cad. Surveyor Date 11/77 State Registration No. LS 706 or Agency

Certified Cor. Record Prepared? Yes No Filed At: _____ Date _____

11

BT'S OK 8/79 Rca REMARKS

Need GUARD Post

Walt Miller PLS-2111 - 8/87

12

Index File No. J 17 T. _____ R. _____ M. _____ Tract or Surv. No. _____ Cor. J-17

13

USDA-FOREST SERVICE

53-0449-3-02829

Index File No. 1959

CORNER RECORD (SEARCH)

(Ref. FSM 7151.4)

Tract or

Survey No.

Cor.

No. J-19

T 155 R. 9E

R.D. SISTERS

County DESCHUTES

3/4 COR. OF

Merid. W.M.

N.F. DESCHUTES

State OREGON

SEC. 11

CORNER DIAGRAM

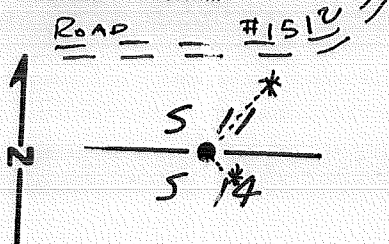

DESCRIBE CORNER MONUMENT FOUND

NONE

DESCRIBE BEARING TREES OR OTHER OFFICIAL ACCESSORIES FOUND

NONE

PHOTO IDENTIFICATION DATA

Photo No. _____

Filed At. _____

Object Ident. _____

Ident. By _____

Signature

PLANE COORDINATE POSITION DATA

State _____ Zone _____

X _____

Y _____

Estab. By _____

Agency

Signature

RCC

Title

PLS 1632

Division

Headquarters

Date

6/84

7100-52-(3, 68)

CORNER RECORD (PERPETUATION)

MONUMENT: DESCRIBE NEW MONUMENT SET, OR WORK DONE TO PRESERVE EXISTING MONUMENT

SET STANDARD USFS 2 1/2" X 30" GALV. PIPE BRASS CAP
 FIRMLY IN GROUND RISING 8" ABOVE NATURAL GRD.
 ERECTED STONE ~~BASE~~ ^{MOUND} AROUND MONUMENT. MARKED
 AS SHOWN

T155 29E

1/4 - 5 11
 5 14
 1984

PLS 1632,

ACCESSORIES: DESCRIBE NEW BT'S WITNESS OBJECTS ETC. ESTABLISHED, OR WORK DONE TO PRESERVE EXISTING EVIDENCE

A 10" DBH P. PINE BEARS N 23° 30' E, 53.43 FT. SCRIBED 1/4, 511, BT
 60d Nail in NW Base
 A 12" DBH P. PINE BEARS S 39° E, 18.96 FT. SCRIBED 1/4, 514, BT.
 60d Nail in SE Base

10

Work Done By RCC Title PLS 1632 Date 6/84 State Registration No. 1632
 for Agency
 Certified Cor. Record Prepared Yes No Filed At: DES. CO. SURV. OFFICE Date 26 June 1984 11

REMARKS

J. H. McCLEUNG, SET 15 X 13 X 8" STONE
 No BTs

53-0466-3-02827 12

Index File No. 1959 T. 155 R. 9E M. W.M. Tract or Surv. No. 53-0466-3-02827 Cor. J-19 13

USDA-FOREST SERVICE

Index
File No. 2159

CORNER RECORD (SEARCH)

(Ref. FSM 7.151.4)

Tract or
Survey No. 000037

Cor.
No. J-21

T. 15 S. R. 9 E.

R.D. SISTERS County DESCHUTES

SW COR. of SEC. 12

Merid. WILLAMETTE

N.F. DESCHUTES State OREGON

NW COR. of SEC. 13

CORNER DIAGRAM PER LEGEND

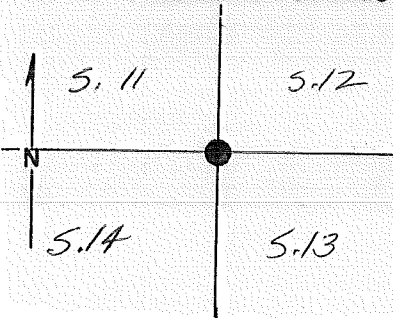

DESCRIBE CORNER MONUMENT FOUND

BRASS CAP 2 1/2" DIAMETER RISING
3" ABOVE GROUND IN GOOD CONDITION. MARKING 5!

T155 R9E L5 706 1977 11/12
17/13

9/93 - Revisited By Walt Miller

DESCRIBE BEARING TREES OR OTHER OFFICIAL ACCESSORIES FOUND

PONDEROSA PINE 9" N15°W 95± FT SCRIBED T155 R9E S11 BT
 " " 10" N28°E 78± FT " T155 R9E S12 BT
 " " 12" S44°E 64± FT " T155 R9E S13 BT
 " " 10" S40°W 76± FT " T155 R9E S14 BT

9/93 Revisited By Walt Miller

DESCRIBE CORNER LOCATION RELATIVE TO NEAR-BY FEATURES, ALSO HOW TO REACH CORNER

PHOTO IDENTIFICATION DATA

Photo No. _____
 Filed At. _____
 Object Ident. _____
 Ident. By _____

Signature

Corner Legend:

- Searched for/Not Found
- Evidence Found/Accept.
- Permanent Monument

Signature

MH/BS

Title

S.T.'s

Division

S.O.

Headquarters

DES. N.F. - BEND

Date

11-81

D-7100-52 (3/79)

CORNER RECORD (PERPETUATION)

MONUMENT. DESCRIBE NEW MONUMENT SET, OR WORK DONE TO PRESERVE EXISTING MONUMENT
SET 2" X 30" GALV. IRON PIPE W/ BRASS CAP

MONUMENT SET

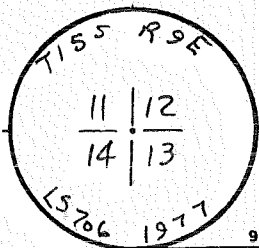

ACCESSORIES DESCRIBE NEW BT'S WITNESS OBJECTS ETC. ESTABLISHED, OR WORK DONE TO PRESERVE EXISTING EVIDENCE

- 10" P. PINE N28°E 78 1/2 FT. B/S
- 12" P. PINE S44°E 64 1/2 FT. ..
- 10" P. PINE S40°W 76 1/2 FT. ..
- 9" P. PINE N15°W 95° FT. ..

10

Work Done By B. ROGERS Title PLS Date 1978 State Registration No. OR-706
 or Agency
 PLAT PREPARED OR **CERTIFIED COR. RECORD PREPARED** **Yes** No Filed At: DESCHUTES CO. SURVEYOR'S OFFICE Date 1/78

11

REMARKS
BR: ED. PILE of STONES. NO MAR. STONE, ALSO 132045 - SCANLON TAGS ON BLAZED TREES.

12

Index File No 2159 T. 15 S., R. 9 E., W.M.

Tract or Surv. No. 000037

Cor. J-21

13

Index

File No. 2359

T 15S R. 9E

Merid. Will

CORNER RECORD (SEARCH)

(Ref. FSM 7151.4)

R.D. SISTERS County DES

N.F. DES State OR

Tract or Survey No. 000037 Cor. No. J-23

5/4 Cor Sec 12

11/4 Cor Sec 13

CORNER DIAGRAM

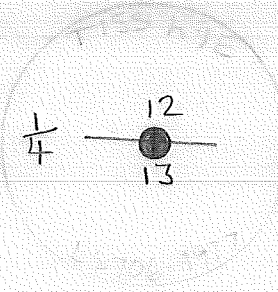

DESCRIBE CORNER MONUMENT FOUND

CONDITION.

2" BRASS CAP RISING 7" IN GOOD

DESCRIBE BEARING TREES OR OTHER OFFICIAL ACCESSORIES FOUND

2

PHOTO IDENTIFICATION DATA

Photo No. _____

Filed At. _____

Object Ident. _____

Ident. By _____

Signature

7

DESCRIBE CORNER LOCATION RELATIVE TO NEAR-BY FEATURES, ALSO HOW TO REACH CORNER

3

PLANE COORDINATE POSITION DATA

State _____ Zone _____

X _____

Y _____

Estab. By _____

Agency

8

Signature

J. PERCIVAL

Title

S.A.

Division

Headquarters

S.O.

Date

11/81

7100-52-(3/68)

4

5

CORNER RECORD (PERPETUATION)

MONUMENT : DESCRIBE NEW MONUMENT SET, OR WORK DONE TO PRESERVE EXISTING MONUMENT

2" Pipe & Cap by proportion
2" X 30" BCSP RSG. 7"



ACCESSORIES : DESCRIBE NEW BT'S WITNESS OBJECTS ETC. ESTABLISHED, OR WORK DONE TO PRESERVE EXISTING EVIDENCE

7" P. pine S75°E 68° MKD. 1/4 S13 BT
8" X" P. pine S21°E 42° MKD. 1/4 S12 BT

Work Done By B. Rogers Title Cad. Surveyor Date 11/77 State Registration No. LS 706
or Agency
Certified ^{PLAT} Cor. Record Prepared? Yes No Filed At: DBS. CO. SURV. OFFICE Date 1/78

REMARKS

Index File No. 2358 T. 155 R. 9 E. M. Tract or Surv. No. 000037 Cor. J-23

Index File No. 2559 CORNER RECORD (SEARCH) Contract or Survey No. 53-0444-3-02829 Cor. No. J-25
 T 15 S. R. 9 E. R.D. SISTERS County DESCHUTES NE Cor. of
 Merid. Willamette N.F. Deschutes State Oregon Section 13

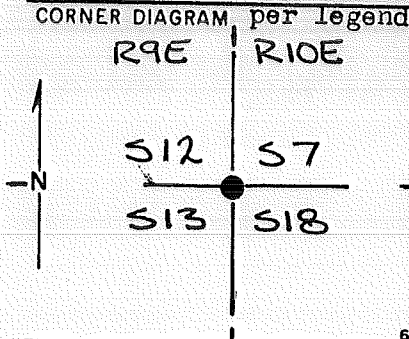

DESCRIBE CORNER MONUMENT FOUND
RISING 16" in Hgt./STN. STANDARD 3 1/4" BLM BRASS
 CAP / 3/4" IRON PIPE 0.20 FT EAST OF BLM
 BRASS CAP, 4 1/2 ft. EAST of DRIFT FENCE.

DESCRIBE BEARING TREES OR OTHER OFFICIAL ACCESSORIES FOUND
 ORIGINAL BT A 24" DBH P. PINE BEARS N26°W
 6.75 FT SCRIBING VISIBLE.

6 16" DBH PINE BEARS N37°W 83.14 FT.
 8" DBH PINE BEARS S74°W 100.35 FT.
 17" DBH PINE BEARS S29 1/2°E 41.27 FT.
 17" DBH PINE BEARS N71°E 32.22 FT.

DESCRIBE CORNER LOCATION RELATIVE TO NEAR-BY FEATURES, ALSO HOW TO REACH CORNER
 FROM SISTERS COW CAMP TAKE NORTH-
 EASTERLY SPUR RD. FOR APPROX. 3/4 MILE
 CORNER LIES SOUTHEASTERLY FROM SHARP
 BEND IN RD. CORNER LIES IN NORTH, SOUTH
 FENCE LINE.

PHOTO IDENTIFICATION DATA
 Photo No. _____
 Filed At. _____
 Object Ident. _____
 Ident. By _____
 Signature _____

CORNER LEGEND:
 FS or Unverified
 Contr. Other
 ○ ◇ Searched For/Not Found
 ⊗ ⊗ Evidence Found/Accept.:
 ● ◆ Permanent Mon. Set/Fd.

Searched By: RCC Title PLS1632 Division _____ Headquarters _____ Date 11-83

CORNER RECORD (PERPETUATION)

MONUMENT: DESCRIBE NEW MONUMENT SET, OR WORK DONE TO PRESERVE EXISTING MONUMENT

NONE - CAP IN GOOD CONDITION

MONUMENT STAMPED

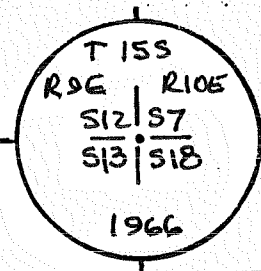

ACCESSORIES : DESCRIBE NEW BT'S WITNESS OBJECTS ETC. ESTABLISHED, OR WORK DONE TO PRESERVE EXISTING EVIDENCE

NONE

Work Done By _____ Title _____ Date _____ State Registration No. or Agency _____

Plat Certified Cor. Record Prepared? Yes No Filed At: _____ Co. Surveyor's Office Date _____

History of Surveys, G.L.O., etc.

J. H. McCLUNG 1870 SET A STONE 14X14X8 & A PINE 15" DIA. BEARS N 25° W 10 LKS DIST.

Index File No. 2559 T. 15 S., R. 9 E., W.M. Contract or Surv. No. 65-644-3-0227 Cor. ~~_____~~

J-25

USDA-FOREST SERVICE

Index File No. 2560

CORNER RECORD (SEARCH)

(Ref. FSM 7.151.4)

Tract or Survey No. _____

Cor. No. K-25

T. 15 S. R. 9 E.

R.D. SISTERS County DESCHUTES

N 1/4 Cor. of SEC. 13/18

Merid. WILLAMETTE

N.F. DESCHUTES State OREGON

Cor. of SEC. _____

CORNER DIAGRAM PER LEGEND

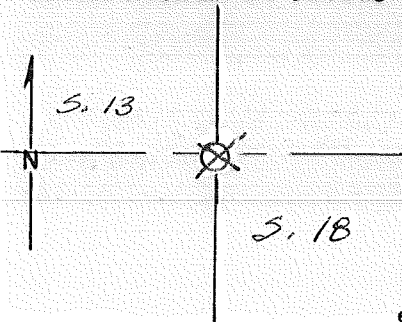

DESCRIBE CORNER MONUMENT FOUND

5/8" REBAR RISING 1" ABOVE GROUND IN GOOD CONDITION. NINE FEET WEST OF N-S FENCE LINE.

DESCRIBE BEARING TREES OR OTHER OFFICIAL ACCESSORIES FOUND

6" P. PINE N 31° W AT 763 FT
5" P. PINE S 62° E AT 427 FT

PHOTO IDENTIFICATION DATA

Photo No. _____
Filed At. _____
Object Ident. _____
Ident. By _____
Signature

DESCRIBE CORNER LOCATION RELATIVE TO NEAR-BY FEATURES, ALSO HOW TO REACH CORNER

Corner Legend:

- Searched for/Not Found
- Evidence Found/Accept.
- Permanent Monument

Signature R. TAYLOR

Title

LSIT

Division

S.D.

Headquarters

DESCHUTES N.F./BEND

Date

8-82

D-7100-52 (3/79)

CORNER RECORD (PERPETUATION)

MONUMENT. DESCRIBE NEW MONUMENT SET, OR WORK DONE TO PRESERVE EXISTING MONUMENT

MONUMENT STAMPED

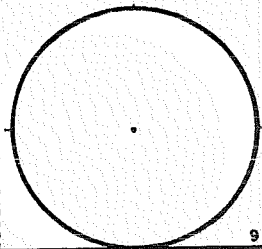

9

ACCESSORIES DESCRIBE NEW BT'S WITNESS OBJECTS ETC. ESTABLISHED, OR WORK DONE TO PRESERVE EXISTING EVIDENCE

10

Work Done By _____ Title _____ Date _____ State Registration No. _____
 or Agency _____
PLAT PREPARED OR
 Certified Cor. Record Prepared? Yes No Filed At: **Co. SURVEYOR'S OFFICE** Date _____

11

REMARKS

Index File No. **2560 T. 15 S., R. 9 E., W.M.**

Tract or Surv. No.

Cor.

K-25

12

13

USDA-FOREST SERVICE

Index File No. 0561

T. 15S S. R. 9

Merid. WILLAMETTE

CORNER RECORD (SEARCH)

(Ref. FSM 7.151.4)

E. R.D. Sisters

N.F. DESCHUTES

Tract or Survey No. _____

County Deschutes

State OREGON

Cor. No. L-5

W/4 Cor. of SEC. 17

Cor. of SEC. _____

CORNER DIAGRAM PER LEGEND



DESCRIBE CORNER MONUMENT FOUND

Nothing found

DESCRIBE BEARING TREES OR OTHER OFFICIAL ACCESSORIES FOUND

none

PHOTO IDENTIFICATION DATA

Photo No. _____

Filed At. _____

Object Ident. _____

Ident. By _____

Signature _____

Corner Legend:

- Searched for/Not Found
- Evidence Found/Accept
- Permanent Monument

DESCRIBE CORNER LOCATION RELATIVE TO NEAR-BY FEATURES, ALSO HOW TO REACH CORNER

Take USFS Rd#1535 south to junction of Rd#1502-A. Turn right, go 0.6 mile north. Stop, walk 200' north along cat trail to corner.

Signature [Handwritten Signature]

Title Surveyor

Division ORLS 980

Headquarters Bend

Date 12/80

D-7100-52 (3/79)

CORNER RECORD (PERPETUATION)

MONUMENT DESCRIBE NEW MONUMENT SET, OR WORK DONE TO PRESERVE EXISTING MONUMENT

Set 2½" Aluminum cap on 2½"X30" Aluminum pipe 26" in ground with mound of stone to cap.

MONUMENT SET

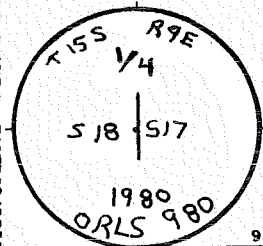

ACCESSORIES DESCRIBE NEW B.T.'s WITNESS OBJECTS ETC. ESTABLISHED, OR WORK DONE TO PRESERVE EXISTING EVIDENCE

5" Fir, N71°E, 4.5', Scribed 1/4 S17, B.T.
 7" Fir, S26°W, 6.1', Scribed 1/4 S18, B.T.
 All B.T.'s have sign 54-4 & 54-3 attached. Set polymer post with 54-4 sign & 54-2a decal, 3.5' north of monument. Painted red band around bearing trees. Tagged trees w/L.S. 980 washer.

10

Work Done By E.W. Graves Title Surveyor Date 12/80 State Registration No. ORLS 980
 or Agency
 Certified Cor. Record Prepared? Yes No Filed At: Deschutes Co. SURVEYOR'S OFFICE Date

11

REMARKS

Witnesses to the above corner: D. Scott
 R. Larson

Index File No. 0561 T. 15 S., R. 9 E., W.M. Tract or Surv. No. Cor. 2-5

12

13

USDA-FOREST SERVICE

Index

File No. 0961

T. 15S S. R. 9E E. R.D. Sisters

Merid. WILLAMETTE

N.F. DESCHUTES

CORNER RECORD (SEARCH)

(Ref. FSM 7.151.4)

Tract or Survey No. _____

Cor. No. L-9

County Deschutes

6/14 COR. of SEC. 17

State OREGON

COR. of SEC. _____

CORNER DIAGRAM PER LEGEND

DESCRIBE CORNER MONUMENT FOUND

Nothing found

DESCRIBE BEARING TREES OR OTHER OFFICIAL ACCESSORIES FOUND

None

DESCRIBE CORNER LOCATION RELATIVE TO NEAR-BY FEATURES, ALSO HOW TO REACH CORNER

Take USFS Rd#1536 to Rd#1536-A. Turn right, go 3.3 miles. Stop, walk north 850' to corner.

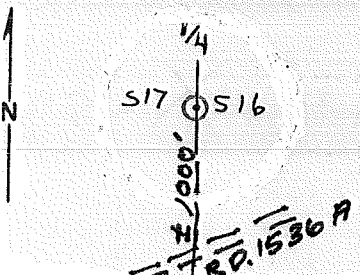

PHOTO IDENTIFICATION DATA

Photo No. _____

Filed At. _____

Object Ident. _____

Ident. By _____

Signature

Corner Legend:

Searched for/Not Found

Evidence Found/Accept.

Permanent Monument

Signature
Edgar Gray

Title
Surveyor

Division
ORLS 980

Headquarters
Bend

Date
12/80

D-7100-52 (3/79)

CORNER RECORD (PERPETUATION)

MONUMENT STAMPED

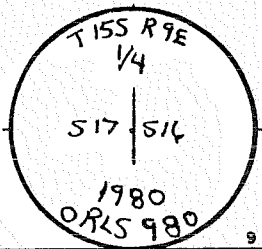

MONUMENT DESCRIBE NEW MONUMENT SET, OR WORK DONE TO PRESERVE EXISTING MONUMENT

Set 2 1/2" Aluminum Cap on 2 1/2" X 30" Aluminum pipe 28" in ground with mound of stone to cap.

ACCESSORIES DESCRIBE NEW BT'S WITNESS OBJECTS ETC. ESTABLISHED, OR WORK DONE TO PRESERVE EXISTING EVIDENCE

6" P.Pine, S61⁰W, 6.0', Scribed 1/4 S17 B.T.
 6" P.Pine, S41 1/2⁰E, 12.7', Scribed 1/4 S16 B.T.
 All B.T.'s have sign 54-4 & 54-3 attached. Set polymer post with 54-4 sign & 54-2a decal, 3' south of monument. Painted red band around bearing trees. Tagged trees w/L.S. 980 washer.

10

Work Done By E.W. Graves Title Surveyor Date 12/80 State Registration No. ORLS 980
 or Agency
PLAT PREPARED OR
 Certified Cor Record Prepared? Yes No Filed At: Deschutes Co. SURVEYOR'S OFFICE Date

11

REMARKS

Witnesses to the above corner: D. Scott
 R. Larson

Index File No. 0961 T 15 S., R. 9 E., W.M. Tract or Surv. No. Cor. L-9

12

13

USDA-FOREST SERVICE

Index

File No. 1361

T. 15 S. R. 9 E.

Merid. WILLAMETTE

CORNER RECORD (SEARCH)

(Ref. FSM 7.151.4)

R.D. Sisters County Deschutes Tract or Survey No. _____

N.F. DESCHUTES State OREGON

Cor. No. L-13

W/4 COR. of SEC. 15

COR. of SEC. _____

CORNER DIAGRAM PER LEGEND

DESCRIBE CORNER MONUMENT FOUND

Nothing found

DESCRIBE BEARING TREES OR OTHER OFFICIAL ACCESSORIES FOUND 2

none

DESCRIBE CORNER LOCATION RELATIVE TO NEAR-BY FEATURES, ALSO HOW TO REACH CORNER 3

Take USFS Rd#1536 to Rd#1536-A, go 2.1 miles to FR-40. Turn left, go 0.4 mile, south. Stop, walk 500' west to fence. Corner is 6' east of fence.

PHOTO IDENTIFICATION DATA

Photo No. _____

Filed At _____

Object Ident. _____

Ident. By _____

Signature _____ 7

Corner Legend:

Searched for/Not Found

Evidence Found/Accept.

Permanent Monument

Signature Edgar Travis

Title

Surveyor

Division

ORIS 980

Headquarters

Bend

Date

12/80

D-7100-52 (3/79)

CORNER RECORD (PERPETUATION)

MONUMENT SET

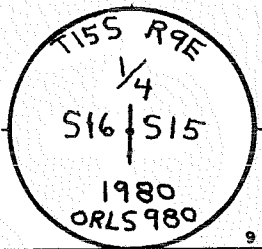

MONUMENT DESCRIBE NEW MONUMENT SET, OR WORK DONE TO PRESERVE EXISTING MONUMENT

Set 2 1/2" Aluminum cap on 2 1/2"X30" Aluminum pipe 24" in ground with mound to stone to cap.

ACCESSORIES DESCRIBE NEW BT'S WITNESS OBJECTS ETC. ESTABLISHED, OR WORK DONE TO PRESERVE EXISTING EVIDENCE

6" P.Pine, N170E, 25.1', Scribed 1/4 S15 B T
8" P.Pine, S300W, 10.0', Scribed 1/4 S16 B T
All B.T.'s have sign 54-4 & 54-3 attached. Set polymer post with 54-4 sign and 54-2a decal, 4' south of monument. Painted red band around bearing trees. Tagged trees w/L.S. 980 washer.

Work Done By E.W. Graves Title Surveyor Date 12/80 State Registration No. ORLS 980
or Agency

PLAT PREPARED OR
Certified Cor Record Prepared? Yes No Filed At: Deschutes Co. SURVEYOR'S OFFICE Date

REMARKS

Witnesses to the above corner: D. Scott
R. Larson

Index File No. 1361 T. 15 S., R. 9 E., W.M. Tract or Surv. No. Cor. 7-13

USDA-FOREST SERVICE

Index

File No. 1561

CORNER RECORD (SEARCH)

(Ref. FSM 7.151.4)

Tract or Survey No. _____

Cor. No. L-15

T. 15 S. R. 9 E. R.D. Sisters

County Deschutes

C/O COR. of SEC. 15

Merid. WILLAMETTE

N.F. DESCHUTES

State OREGON

COR. of SEC. _____

CORNER DIAGRAM PER LEGEND

DESCRIBE CORNER MONUMENT FOUND

Nothing found

DESCRIBE BEARING TREES OR OTHER OFFICIAL ACCESSORIES FOUND

none

DESCRIBE CORNER LOCATION RELATIVE TO NEAR-BY FEATURES, ALSO HOW TO REACH CORNER

Take USFS Rd#1536S to Rd# 1536-A. Go 1.9 miles to FR-40.
Take left for 1 mile, stop, walk north 200' to corner.

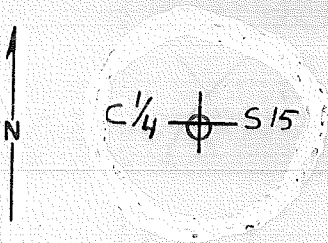

PHOTO IDENTIFICATION DATA

Photo No. _____

Filed At. _____

Object Ident. _____

Ident. By _____

Signature _____

Corner Legend:

Searched for/Not Found

Evidence Found/Accept

Permanent Monument

Signature [Handwritten Signature]

Title
Surveyor

Division
ORLS 980

Headquarters
Bend

Date
12/80

D-7100-52 (3/79)

CORNER RECORD (PERPETUATION)

MONUMENT DESCRIBE NEW MONUMENT SET, OR WORK DONE TO PRESERVE EXISTING MONUMENT

Set 2 1/2" Aluminum cap on 2 1/2" X 30" Aluminum pipe 27" in ground with mound of stone to cap.

MONUMENT STAMPED

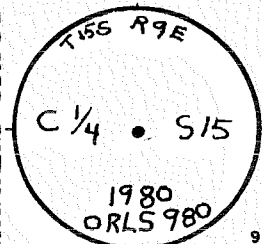

ACCESSORIES DESCRIBE NEW BT'S WITNESS OBJECTS ETC. ESTABLISHED, OR WORK DONE TO PRESERVE EXISTING EVIDENCE

4" P.Pine, N52 1/2° W, 14.2', Scribed X B.T.
 8" P.Pine, N41° E, 39.3', Scribed 1/4 S15 B.T.
 All B.T.'s have sign 54-3 and 54-9 attached. Set steel post with 54-9 sign, 4' north of monument. Painted red band around bearing trees. Tagged trees w/L.S 980 washer.

Work Done By E.W. Graves Title Surveyor Date 12/80 State Registration No. ORLS 980
 or Agency

PLAT PREPARED OR
 Certified Cor Record Prepared? Yes No Filed At: Deschutes Co. SURVEYOR'S OFFICE Date

REMARKS

Witnesses to the above corner: D. Scott
 R. Taylor

Index File No 1561 T 15 S., R. 9 E., W.M. Tract or Surv. No. Cor. L-15

USDA-FOREST SERVICE

Index
File No. 1761

CORNER RECORD (SEARCH)
(Ref. FSM 7.151.4)

Tract or
Survey No. _____

Cor.
No. L-17

T. 15 S. R. 9 E. R.D. Sisters County Deschutes

E/4 COR. of SEC. 15

Merid. WILLAMETTE N.F. DESCHUTES State OREGON

COR. of SEC. _____

CORNER DIAGRAM PER LEGEND

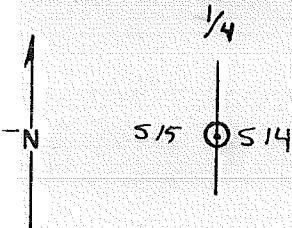

DESCRIBE CORNER MONUMENT FOUND

Nothing found

DESCRIBE BEARING TREES OR OTHER OFFICIAL ACCESSORIES FOUND

None

PHOTO IDENTIFICATION DATA

Photo No. _____

Filed At. _____

Object Ident. _____

Ident. By _____

Signature

DESCRIBE CORNER LOCATION RELATIVE TO NEAR-BY FEATURES, ALSO HOW TO REACH CORNER

Take USFS Rd#1436S to Rd#1536-A, go 1.9 miles to FR-40. Turn left, go 0.7 miles to spur road heading east. Go to end, stop, walk 400' uphill (south) to corner.

Corner Legend:

Searched for/Not Found

Evidence Found/Accept

Permanent Monument

Signature
Edgar Graves

Title
Surveyor

Division
ORLS 980

Headquarters
Bend

Date
12/80

D-7100-52 (3/79)

CORNER RECORD (PERPETUATION)

MONUMENT DESCRIBE NEW MONUMENT SET, OR WORK DONE TO PRESERVE EXISTING MONUMENT

Set 2½" Aluminum cap on 2½"X30" Aluminum pipe 27" in ground with mound of stone to cap.

MONUMENT STAMPED

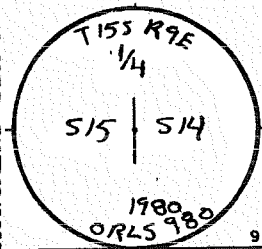

ACCESSORIES DESCRIBE NEW B.T.'s WITNESS OBJECTS ETC. ESTABLISHED, OR WORK DONE TO PRESERVE EXISTING EVIDENCE

6" P.Pine, N53°E, 42.6', Scribed 1/4 S14 B.T. - 5' High Stump 6/1/94 M. Wilson
 6" P.Pine, S48°W, 11.4', Scribed 1/4 S15 B.T.
 All B.T.'s have sign 54-4 & 54-3 attached. Set polymer post with 54-4 sign and 54-2a decal, 3' north of monument. Painted red band around bearing trees. Tagged trees w/L.S. 980 washer.

Work Done By E.W. Graves Title Surveyor Date 12/80 State Registration No. ORLS 980
 or Agency

PLAT PREPARED OR
 Certified Cor Record Prepared? Yes No Filed At: Deschutes Co. SURVEYOR'S OFFICE Date

REMARKS

Witnesses to the above corner: D. Scott
 R. Taylor

Index File No. 1761 T. 15 S., R. 9 E., W. M. Tract or Surv. No. Cor. L-19

Index

File No. 2161

CORNER RECORD (SEARCH)

(Ref. FSM 7151.4)

53-0466-3-02829

Tract or

Survey No.

Cor.

No. L-21

T 15S R. 9E

R.D. SISTERS County DESCHUTES W 1/4 EDR OF

Merid. WM

N.F. DESCHUTES State OREGON SEC. 13

CORNER DIAGRAM

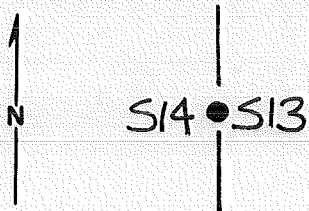

DESCRIBE CORNER MONUMENT FOUND

NONE

DESCRIBE BEARING TREES OR OTHER OFFICIAL ACCESSORIES FOUND

NONE

PHOTO IDENTIFICATION DATA

Photo No. _____

Filed At. _____

Object Ident. _____

Ident. By _____

Signature

PLANE COORDINATE POSITION DATA

State _____ Zone _____

X _____

Y _____

Estab. By _____

Agency

DESCRIBE CORNER LOCATION RELATIVE TO NEAR-BY FEATURES, ALSO HOW TO REACH CORNER

FROM SISTERS COWCAMP TAKE THE DIRT RD. ON THE SOUTH END OF CAMP THEN TAKE FIRST RD. TO THE SOUTH FOLLOW RD. TO LOCATION TAG ON BIG PINE. CORNER IS WEST OF THE RD.

Signature

RCC

Title

PLS 1632

Division

+

Headquarters

Date

4/84

7100-52 (3/68)

T
CORNER RECORD (PERPETUATION)

MONUMENT: DESCRIBE NEW MONUMENT SET, OR WORK DONE TO PRESERVE EXISTING MONUMENT
 SET STANDARD USFS 2 1/2" X 30" GALV. PIPE & BRASS CAP
 FIRMLY IN GROUND RISING 10" ABOVE NATURAL
 GROUND ERECTED STONE ^{MOUND} ~~PILE~~ AROUND
 MONUMENT. MARK AS SHOWN

TISS R9E
 1/4
 S14 S13
 1984
 PLS 1632

ACCESSORIES: DESCRIBE NEW BT'S WITNESS OBJECTS ETC. ESTABLISHED, OR WORK DONE TO PRESERVE EXISTING EVIDENCE

12" DBH P. PINE BEARS N66°W 66.52 FT. SCRIBED "1/4 S14 BT"
GOD NAIL IN NNE BASE
 11" DBH P. PINE BEARS N52 1/2°E 79.31 FT. SCRIBED "1/4 S13 BT"
GOD NAIL IN SE BASE

10

Work Done By RCC Title PLS Date 4/84 State Registration No. 1632
 or Agency
 Certified Cor. Record Prepared? Yes No Filed At: DES. CO. SURV. OFFICE Date 31 MAY 1984 11

REMARKS

J.H. McCLUNG SET A 16X10X10 STONE
 NO BT'S

Revisited By Walt Muller - 9/83

53-0466-3-02829

12

Index File No. 2161 T. 155 R. 9E M. WJM Tract or Surv. No. Cor. L-21 13
 U.S. G.P.O. 1977-725-576/586

Index

File No. 2561

CORNER RECORD (SEARCH) Contract or
(Ref. FSM 7151.4) Survey No.

53-0449-3-02829

Cor. No. L-25

T 15 S. R. 9 E. R.D. SISTERS County DESCHUTES E'1/4 Cor. of

Merid. Willamette N.F. Deschutes State Oregon Section 13

CORNER DIAGRAM

Legend

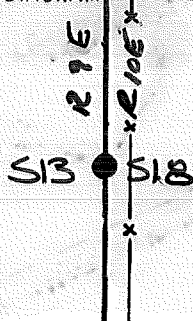

DESCRIBE CORNER MONUMENT FOUND

NONE FOUND G. COOK L.S.
540 PROPORTIONED CORNER 21.45 TO THE
WEST OF OUR ~~RD~~ PROPORTIONED LOCATION

DESCRIBE BEARING TREES OR OTHER OFFICIAL ACCESSORIES FOUND

NONE

PHOTO IDENTIFICATION DATA

Photo No. _____

Filed At. _____

Object Ident. _____

Ident. By _____

Signature _____

DESCRIBE CORNER LOCATION RELATIVE TO NEAR-BY FEATURES, ALSO HOW TO REACH CORNER

FROM SISTERS COW CAMP TAKE THE MOST
EASTERLY RUNNING DIRT RD. FOR ALMOST A MILE
WHEN RD. STARTS TURNING SHARPLY BACK. ~~RD~~
~~RD~~ EAST OF RD. 300'± IS A FENCE FOLLOW
FENCE LINE SOUTH TO CORNER

CORNER LEGEND:

- FS or Unverified
- Contr. Other
- Searched For/Not Found
- ◇ Evidence Found/Accept.:
- ⊗ Permanent Mon. Set/Fd.

Searched By:

RCC

Title

PLS1632

Division

Headquarters

Date

3/23/84

CORNER RECORD (PERPETUATION)

MONUMENT: DESCRIBE NEW MONUMENT SET, OR WORK DONE TO PRESERVE EXISTING MONUMENT
14 1/2 FT. WEST OF FENCE LINE.

SET STANDARD USES 2 1/2" X 30" GALV PIPE & BRASS CAP
RISING 24" ABOVE NATURAL GROUND HIT SOLID
ROCK 6" BELOW SURFACE ERECTED HUGE!! &
SUBSTANTIAL ROCK MOUND & DIRT IN THE CENTER OF MOUND

MONUMENT STAMPED

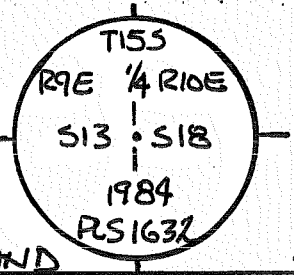

ACCESSORIES: DESCRIBE NEW BT'S WITNESS OBJECTS ETC. ESTABLISHED, OR WORK DONE TO PRESERVE EXISTING EVIDENCE
60d NAIL IN NW BASE

5" DBH P. PINE BEARS N 30° W 7.44 FT SCRIBED "1/4 S13 BT"
7" DBH P. PINE BEARS N 40 1/2° E 26.88 FT. SCRIBED "1/4 S18 BT"
60d NAIL IN NW BASE

Work Done By: RCC Title: PLS Date: _____ State Registration No. 1632
or Agency _____
Platted or Cor. Record Prepared? Yes No Filed At: Desch. Co. Surveyor's Office Date 3 MAY 1984

History of Surveys, G.L.O., etc. J.H. McCLUNG IN 1870 SET A STONE 16X12X7

Index File No. 2561 T. 15 S., R. 9 E., W.M. Contract or Surv. No. 53-0466-3-02829 Cor. L-25

USDA-FOREST SERVICE

Index
File No. 1362

CORNER RECORD (SEARCH)
(Ref. FSM 7.151.4)

Tract or
Survey No. _____

Cor.
No. M-13

T. 15 S. R. 9 E. R.D. Sisters

County Deschutes

5/16 COR. of SEC. 15416

Merid. WILLAMETTE

N.F. DESCHUTES

State OREGON

COR. of SEC. _____

CORNER DIAGRAM PER LEGEND

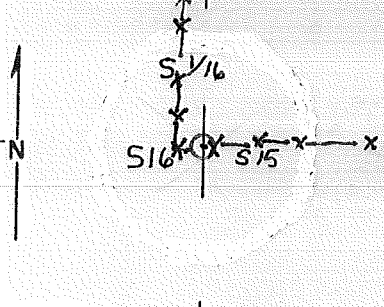

DESCRIBE CORNER MONUMENT FOUND

Nothing found

DESCRIBE BEARING TREES OR OTHER OFFICIAL ACCESSORIES FOUND

none

PHOTO IDENTIFICATION DATA

Photo No. _____
 Filed At. _____
 Object Ident. _____
 Ident. By _____
Signature

DESCRIBE CORNER LOCATION RELATIVE TO NEAR-BY FEATURES, ALSO HOW TO REACH CORNER

Take USFS Rd#1536 to Rd#1536-D. Turn right to Fr-35. Go to FR-20, turn left, go 1.8 miles. Stop, walk 500' north (downhill) to corner.

Corner Legend:

- Searched for/Not Found
- Evidence Found/Accept
- Permanent Monument

Signature
Earl Graves

Title E.W. Graves Division ORLS 980 Headquarters Bend Date 12/80 D-7100-52 (3/79)

CORNER RECORD (PERPETUATION)

MONUMENT STAMPED

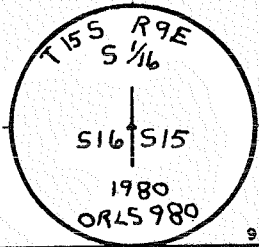

MONUMENT DESCRIBE NEW MONUMENT SET, OR WORK DONE TO PRESERVE EXISTING MONUMENT

Set 2 1/2" Aluminum cap on 2 1/2" X 30" Aluminum pipe 22" in ground with mound of stone to cap.

ACCESSORIES DESCRIBE NEW BT'S WITNESS OBJECTS ETC. ESTABLISHED, OR WORK DONE TO PRESERVE EXISTING EVIDENCE

6" P.Pine, S52°E, 16.4', Scribed S1/16 S15 B T
 6" P.Pine, S42°W, 32.1', Scribed S1/16 S16 B T
 All B.T.'s have sign 54-9 & 54-3 attached. Set polymer post with 54-9 sign and 54-2a decal. Painted red band around bearing trees. Tagged trees w/L.S. 980 washer.

Work Done By E.W. Graves Title Surveyor Date 12/80 State Registration No. ORLS 980
 or Agency _____
PLAT PREPARED OR No Yes
 Certified Cor Record Prepared? No Yes
 Filed At: Deschutes **Co. SURVEYOR'S OFFICE** Date _____

REMARKS

Witnesses to the above corner: D. Scott
 R. Larson

Index File No. 1362 T 15 S, R 1 E., W.M. Tract or Surv. No. Cor. M-13

USDA-FOREST SERVICE

Index

File No. 1562

CORNER RECORD (SEARCH)

(Ref. FSM 7151.4)

Tract or

Survey No.

Cor.

No. M-15

T. 15 S. R. 9 E. R.D. Sisters

County

Deschutes

CS 1/16

COR. of SEC. 15

Merid. WILLAMETTE

N.F. DESCHUTES

State

OREGON

COR. of SEC.

CORNER DIAGRAM PER LEGEND

DESCRIBE CORNER MONUMENT FOUND

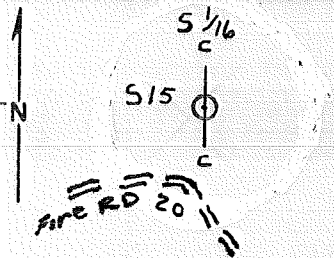

Nothing found

DESCRIBE BEARING TREES OR OTHER OFFICIAL ACCESSORIES FOUND

none

PHOTO IDENTIFICATION DATA

Photo No. _____

Filed At. _____

Object Ident. _____

Ident. By _____

Signature

6

DESCRIBE CORNER LOCATION RELATIVE TO NEAR-BY FEATURES, ALSO HOW TO REACH CORNER

Take USFS Rd#1536S to Rd#1536-D, turn right, go to FR-35. Turn right, go to FR-20, turn left for 1 mile. Stop, walk north to fence, then east to corner.

3

Corner Legend:

Searched for/Not Found

Evidence Found/Accept.

Permanent Monument

Signature
Edgar Swave

Title
Surveyor

Division
ORLS 980

Headquarters
Bend

Date
12/80

D-7100-52 (3/79)

1

CORNER RECORD (PERPETUATION)

MONUMENT DESCRIBE NEW MONUMENT SET, OR WORK DONE TO PRESERVE EXISTING MONUMENT

Set 2 1/2" Aluminum cap on 2 1/2"X30" Aluminum pipe . " in ground with mound of stone to cap.

MONUMENT STARTED

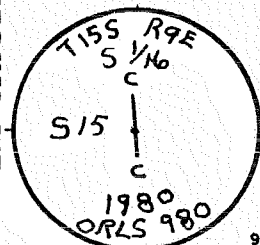

ACCESSORIES DESCRIBE NEW BT'S WITNESS OBJECTS ETC. ESTABLISHED, OR WORK DONE TO PRESERVE EXISTING EVIDENCE

6" P.Pine, S60°E, 11.7', Scribed 1/16 S15. B T.
 6" P.Pine, S02°W, 8.6', Scribed 1/16 S15 B T.
 All B.T.'s have sign 54-3 & 54-9 attached. Set steel post with 54-9 sign, 3' west of monument and polymer post with 54-2a sign, 4' west of monument. Painted red band around bearing trees. Tagged trees w/L.S. 980 washer.

Work Done By E.W. Graves Title Surveyor Date 12/80 State Registration No. ORLS 980
 or Agency
 PLAT PREPARED OR Certified Cor Record Prepared? Yes No Filed At: Deschutes Co. SURVEYOR'S OFFICE Date

REMARKS

Witnesses to the above corner: D. Scott
 R. Taylor

Index File No. 1562 T. 15 S., R. 9 E., W.M. Tract or Surv. No. Cor. 15

USDA-FOREST SERVICE

Index

File No. 1762

T. 15 S. R. 9

E. R.D. Sisters

CORNER RECORD (SEARCH)

(Ref. FSM 7.151.4)

Tract or

Survey No. _____

Cor. No. M-17

Merid. WILLAMETTE

N.F. DESCHUTES

County Deschutes

State OREGON

5/16 COR. of SEC. 15 & 14

COR. of SEC. _____

CORNER DIAGRAM PER LEGEND

DESCRIBE CORNER MONUMENT FOUND

Nothing found

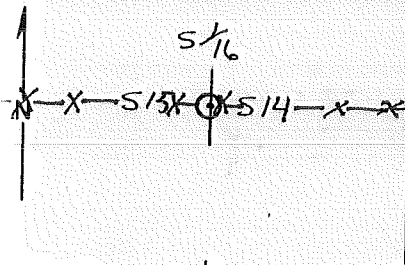

DESCRIBE BEARING TREES OR OTHER OFFICIAL ACCESSORIES FOUND

none

PHOTO IDENTIFICATION DATA

Photo No. _____

Filed At. _____

Object Ident. _____

Ident. By _____

Signature

Corner Legend:

Searched for/Not Found

Evidence Found/Accept

Permanent Monument

DESCRIBE CORNER LOCATION RELATIVE TO NEAR-BY FEATURES, ALSO HOW TO REACH CORNER

Take U.S.F.S. Rd#1536S to Rd#1536-A, go 1.9 miles to FR-40. Turn left, go 1.0 mile, stop, walk south to fence then east to corner. Corner is on north side of fence.

Signature [Handwritten Signature]

Title _____
Surveyor ORLS 980

Division _____
Headquarters Bend

Date 12/80

D-7100-52 (3/79)

CORNER RECORD (PERPETUATION)

MONUMENT DESCRIBE NEW MONUMENT SET, OR WORK DONE TO PRESERVE EXISTING MONUMENT

Set 2½" Aluminum cap on 2½"X30" Aluminum pipe 22" in ground with mound of stone to cap.

MONUMENT SET

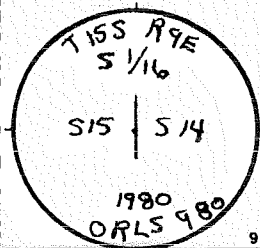

ACCESSORIES DESCRIBE NEW B.T.'s WITNESS OBJECTS ETC. ESTABLISHED, OR WORK DONE TO PRESERVE EXISTING EVIDENCE

7" P.Pine, N52½°E, 29.0', Scribed 1/16 S14 B.T.
 8" P.Pine, S89°W, 5.8', Scribed 1/16 S15 B.T.
 All B.T.'s have sign 54-4 & 54-3 attached. Set polymer post with 54-9 sign and 54-2a decal, 3' north and west of monument. Painted red band around bearing trees. Tagged trees w/L.S. 980 washer.

Work Done By E.W. Graves Title Surveyor Date 12/80 State Registration No. ORLS 980
 or Agency
PLAT PREPARED OR Deschutes **Co. SURVEYOR'S OFFICE**
 Certified Cor. Record Prepared? Yes No Filed At Date

REMARKS

Witnesses to the above corner: D. Scott
 R. Taylor

Index File No. 1762 T. 15 S., R. 9 E., W.M. Tract or Surv. No. Cor. M-17

LAND CORNER RECORD

N-5

(Rectangular)

1. T. 15S R. 9E No. N-5 Cor. Sec. Mer. Will State Oregon N. F. Deschutes Dist. Sisters

2. Corner Status

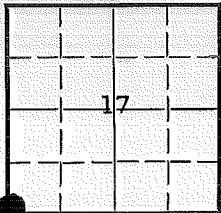

3. Original Description Vol. Page Where Recorded

4. Description of Corners: 10-6-1870 Set stone 15x11x5 for cor. to secs. 17, 18, 19, & 20 - from which, a Fir 24 in. bears N57°E, 30 lks. dist.

7. Photo Identification 7-14-59

Photo No. EG1-51-1
Ident. By: O. Thingvall

5. Investigation Notes: Found pile of stones; one measuring 15x11x4 ins. above the ground in fair condition with no markings. No B.T. USFS & B-S, Inc section corner tags.

8. Plane Coordinate Position Data

State Zone
X
Y

Section corner is 273' west from section line marker between sections 17 & 20 on Rd 15022-A, AND 200' WEST of same Road.
Found Line Trees North and East. Rec'd 7/79
150' 4' 400' 230'
WEST
215'

Estab. By

Field Book No.
Where Filed

9. Evaluation

Authentic
Needs Verif. Monument
Re-estab. Survey
Land Status

6. Signed O. Thingvall Title Hwy. Eng. Date 5-28-63

PERPETUATION RECORD

10. Monument: FROM STONE & LINE TREES
 SET 2 1/2" X 32" BRASS-CAPPED STEEL PIPE
 RISING 4" IN MOUND OF STONES

TISS
 R 1817
 S 1920
 E
 R.OMAN PLS
 OR-702

11. Accessories

7" W. FIR N19°W 17 1/2 FT. MKD. TISS R9E 318 BT ~ 60d NL. E.
 4" " N48°E 27 1/2 " " "X BT" ~ 60d NL. NW BASE
 4" " S48°E 27 " " " " " SW "
 8" " S62°W 26 1/2 " " TISS R9E S19 BT ~ 60d NL. SE BASE

Field Book _____ Page _____

12. Set By R.OMAN Title PLS
 License OR-702 Agency _____ Date 9/79

13. Recorded By _____ Volume _____ Page _____
 (Agency)
 (Date) (City) (County) (State)

14. Remarks:

Index _____
 File No. 0963
 T 15 S. R. 9 E. R.D. SISTERS Contract or Survey N^o. _____
 Merid. Willamette N.F. Deschutes County DESCHUTES Cor. No. N-09
 State Oregon Section 16

CORNER DIAGRAM, per legend

DESCRIBE CORNER MONUMENT FOUND

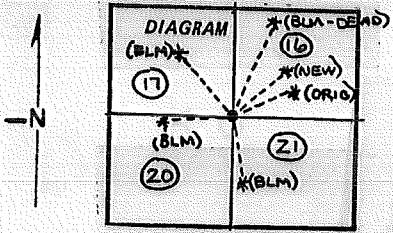

ORIGINAL DESCRIPTION: Set stone 14 x 12 x 8 for cor to Secs 16, 17, 20 & 21 - from which
 a Pine 18 in dia bears N 50° E. 33 lks dist

B.L.M. -- 1966 by James E. Jolley - Set an iron post, 28 ins. long, 2½ ins. diam., 24 ins. in the ground, with brass cap mkd. (as shown below) from which new bearing tree:
 1) A pine, 16 ins. diam., bears N.25½°E., 77 lks. dist., mkd. T15S R9E S16 BT.
 2) A white fir, 6 ins. diam., bears S.9½°E., 31 lks. dist., mkd. T15S R9E S21 BT.
 3) A white fir, 6 ins. diam., bears S.83°W., 33 lks. dist., mkd. T15S R9E S20 BT.
 4) A white fir, 6 ins. diam., bears N. 35½°W., 48 lks. dist., mkd. T15S R9E S17 BT.
 Description of corner evidence found:

Found 3¼" brass cap on a 2½" iron post rising 5" with an unmarked stone alongside the cap.
 1) A 17" Ponderosa Pine - bears N 25°E at 50.8 ft. - scribed T15SR9ES16BT - Dead- (BLM)
 2) A 7" White Fir - bears S 09°E at 20.5 ft. - healed over (BLM)
 3) A 8" " " - " S 83°W " 21.8 ft. - " " "
 4) A 8" " " - " N35½°W " 31.7 ft. - " " "
 A 29" Ponderosa Pine bears N 50°E at 21.8 ft. - scribing illegible (GLO Orig.)

PHOTO IDENTIFICATION DATA

Photo No. _____
 Filed At. _____
 Object Ident. _____
 Ident. By _____
 Signature _____

CORNER LEGEND:

- FS or Unverified
- Contr. Other
- ◇ Searched For/Not Found
- ⊗ ⊗ Evidence Found/Accept.
- ◆ Permanent Mon. Set/Pd.

Searched By:

Title _____ Division _____ Headquarters _____ Date _____

CORNER RECORD (PERPETUATION)

MONUMENT. DESCRIBE NEW MONUMENT SET, OR WORK DONE TO PRESERVE EXISTING MONUMENT

MONUMENT STAMPED

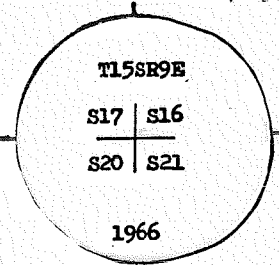

9

ACCESSORIES. DESCRIBE NEW BT'S WITNESS OBJECTS ETC. ESTABLISHED, OR WORK DONE TO PRESERVE EXISTING EVIDENCE

New Bearing Tree

A 10" Ponderosa Pine bears N 43° E at 41.15 ft. to a 60-Penny spike in the SE base, marked T15SR9ES16BT.

10

Work Done By W. MILLER Title PLS Date 11/14/85 State Registration No. 2111
 or Agency _____
 Certified For Record Prepared Yes No Filed At DESCHUTES Co. Surveyor's Office Date 11/14/85

11

History of Surveys, G.L.O., etc.

SEE FRONT

12

Index File No. T. S., R. E., W.M. Contract or Surv. No. Cor. 13

USDA-FOREST SERVICE

Index
File No. 0763

T. 15 S. R. 9 E. R.D. Sisters

Merid. WILLAMETTE

CORNER RECORD (SEARCH)

(Ref. FSM 7.151.4)

Tract or
Survey No. Deschutes

Cor.
No. N-7

County

Deschutes

5/4 COR. of SEC. 17

State

OREGON

COR. of SEC.

CORNER DIAGRAM PER LEGEND

DESCRIBE CORNER MONUMENT FOUND

Nothing found

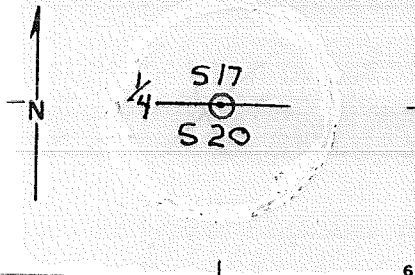

DESCRIBE BEARING TREES OR OTHER OFFICIAL ACCESSORIES FOUND

none

PHOTO IDENTIFICATION DATA

Photo No. _____

Filed At. _____

Object Ident. _____

Ident. By _____

Signature

DESCRIBE CORNER LOCATION RELATIVE TO NEAR-BY FEATURES, ALSO HOW TO REACH CORNER

Take USFS Rd#1536 to Rd#1536-A. Turn right, go 3.6 miles to cabin. Stop, walk 2000' west to corner.

Corner Legend:

Searched for/Not Found

Evidence Found/Accept.

Permanent Monument

Signature

Edgar Gave

Title

Surveyor

Division

ORLS 980

Headquarters

Bend

Date

12/80

D-2100-52 (3/79)

CORNER RECORD (PERPETUATION)

MONUMENT STAMPED

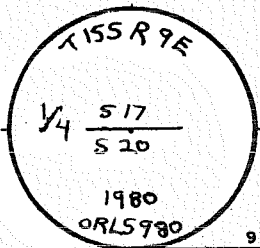

MONUMENT DESCRIBE NEW MONUMENT SET, OR WORK DONE TO PRESERVE EXISTING MONUMENT

Set 2½" Aluminum cap on 2½"X30" Aluminum pipe 26" in ground with mound of stone to cap.

ACCESSORIES DESCRIBE NEW BT'S WITNESS OBJECTS ETC. ESTABLISHED, OR WORK DONE TO PRESERVE EXISTING EVIDENCE

6" Fir, N23°W, 10.0', Scribed 1/4 S17 B T
 6" Fir, S69°W, 24.2', Scribed 1/4 S20 B T
 All B.T.'s have sign 54-4 & 54-3 attached. Set polymer post 3.5' east of monument with 54-4 sign and 54-2a decal. Painted red band around bearing trees. Tagged trees with L.S. 980 washer.

10

Work Done By E.W. Graves Title Surveyor Date 12/80 State Registration No. ORLS 980
 or Agency _____
 PLAT PREPARED OR
 Certified Cor Record Prepared? Yes No Filed At: Co. SURVEYOR'S OFFICE Date _____

11

REMARKS

Witnesses to the above corner: D. Scott
 R. Larson

12

Index File No. 0763 T. 15 S., R. 9 E., W.M. Tract or Surv. No. _____ Cor. N-7

13

USDA-FOREST SERVICE

Index

File No. 1163

CORNER RECORD (SEARCH)

(Ref. FSM 7.151.4)

Tract or

Survey No.

Cor.

No. N-11

T. 15 S. R. 9 E.

R.D. Sisters

County

Deschutes

5/4

COR. of SEC. 16

Merid. WILLAMETTE

N.F. DESCHUTES

State

OREGON

COR. of SEC.

CORNER DIAGRAM PER LEGEND

DESCRIBE CORNER MONUMENT FOUND

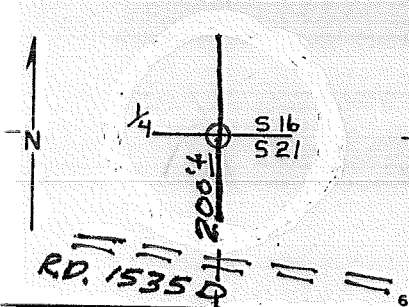

Nothing found

DESCRIBE BEARING TREES OR OTHER OFFICIAL ACCESSORIES FOUND

none

PHOTO IDENTIFICATION DATA

Photo No. _____

Filed At. _____

Object Ident. _____

Ident. By _____

Signature

DESCRIBE CORNER LOCATION RELATIVE TO NEAR-BY FEATURES, ALSO HOW TO REACH CORNER

Take USFS Rd# 1536 Southwest to Rd#1536-D. Turn right and go 2.2 miles. Stop and walk 200' north of road to corner.

Corner Legend:

Searched for/Not Found

Evidence Found/Accept

Permanent Monument

Signature Edgar Gave

Title

Surveyor

Division

ORIS 080

Headquarters

Bend

Date

12/80

D-7100-52 (3/79)

CORNER RECORD (PERPETUATION)

MONUMENT DESCRIBE NEW MONUMENT SET, OR WORK DONE TO PRESERVE EXISTING MONUMENT

Set 2½" Aluminum cap on 2½"X30" Aluminum pipe 23" in ground with mound of stone to cap.

MONUMENT SET/STAMPED

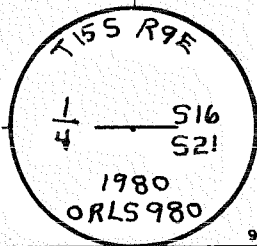

ACCESSORIES DESCRIBE NEW B.T.'s WITNESS OBJECTS ETC. ESTABLISHED, OR WORK DONE TO PRESERVE EXISTING EVIDENCE

6" P.Pine, N150W, 6.0', Scribed 1/4 S16 B.T.
 6" P.Pine, S66½°W, 12.5', Scribed 1/4 S21 B.T.
 All B.T.'s have sign 54-4 & 54-3 attached. Set polymer post with 54-4 sign and 54-2a decal, 3.5', east of monument. Painted red band around bearing trees. Tagged trees w/L.S. 980 washer.

Work Done By E.W. Graves Title Surveyor Date 12/80 State Registration No. ORLS 980
 or Agency _____

PLAT PREPARED OR
 Certified Cor. Record Prepared? Yes No _____ Filed At: Deschutes Co. SURVEYOR'S OFFICE Date _____

REMARKS

Witnesses to the above corner: D. Scott
 R. Larson

Index File No. 1163 T. 15 S., R. 9 E., W.M. Tract or Surv. No. _____ Cor. N - 113

Index

File No. 1363

CORNER RECORD (SEARCH) Contract or

(Ref. FSM 7151.4)

Survey No.

Cor.

No. N-13

T 15 S. R. 9 E. R.D. SISTERS

County DESCHUTES

SW Cor. of

Merid. Willamette

N.F. Deschutes

State Oregon

Section 15

CORNER DIAGRAM, per legend

DESCRIBE CORNER MONUMENT FOUND

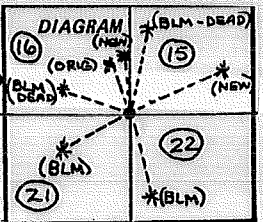

ORIGINAL DESCRIPTION: Set stone 36 x 20 x 15 for cor to Secs 15 & 16, 21 & 22 from which

a Pine 16 in dia N 20° W. 20 lks dist

B.L.M. - 1966 by James E. Jelley - Set an iron post, 28 ins. long, 2 1/2 ins. diam., 24 ins. in the ground, with brass cap mkd. (as shown below) from which new bearing trees

DE

- 1) A pine, 7 ins. diam., bears N.10 1/2° E., 3 1/2 lks. dist., mkd. T15S R9E S15 BT.
- 2) A white fir, 8 ins. diam., bears S.17 1/2° E., 38 lks. dist., mkd. T15S R9E S22 BT.
- 3) A white fir, 10 ins. diam., bears S. 58° W., 27 lks. dist., mkd. T15S R9E S21 BT.
- 4) A pine, 5 ins. diam., bears N.6 1/2° W., 28 1/2 lks, dist., mkd. T15S R9E S16 BT.

Description of corner evidence found:

- Found 3/4" brass cap on a 2 1/2" iron post rising 5"
- 9" Ponderosa Pine bears N10°E at 22.8 ft., marked T15SR9ES15BT, dead. (BLM)
- 13" White Fir bears S17 1/2°E at 25.1 ft., healed over. (BLM)
- 16" " " " S58°W " 17.8 ft., " " "
- 6" Ponderosa Pine bears N6 3/4°W at 18.8 ft., marked T15SR9ES16BT, dead. (BLM)
- 16" down log bears N15°W at 13 ft., marked T15S R BT. (GLO Orig.)

DESCRIBE CORNER LOCATION RELATIVE TO NEARBY FEATURES, ALSO HOW TO REACH CORNER

PHOTO IDENTIFICATION DATA

Photo No. _____

Filed At. _____

Object Ident. _____

Ident. By _____

Signature

CORNER LEGEND:

- FS or Unverified
- Contr. Other
- ◇ Searched For/Not Found
- ⊗ ⊗ Evidence Found/Accept.
- ◆ Permanent Mon. Set/Pd.

Searched By:

Title

Division

Headquarters

Date

CORNER RECORD (PERPETUATION)

MONUMENT. DESCRIBE NEW MONUMENT SET, OR WORK DONE TO PRESERVE EXISTING MONUMENT

MONUMENT STAMPED

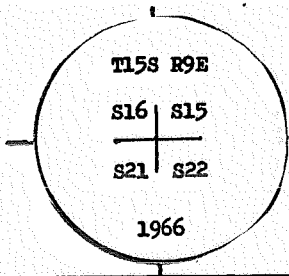

ACCESSORIES DESCRIBE NEW BT'S WITNESS OBJECTS ETC. ESTABLISHED, OR WORK DONE TO PRESERVE EXISTING EVIDENCE

New Bearing Trees

A 7" Ponderosa Pine bears N04°W at 33.02 ft. to a 60-Penny spike in the SW base, marked T158R9E816BT.

A 6" Ponderosa Pine bear N 64°E at 19.92 ft. to a 60-Penny spike in the NW base, marked T158R9E815BT.

Work Done By W. MILLER Title PLS Date 11/14/85 State Registration No. 2111
or Agency

Plate Per Record Prepared? Yes No Filed At DESCHUTES Co. Surveyor's Office Date 11/14/85

History of Surveys, G.L.O., etc. SEE FRONT

Index File No. T. S., R. E., W.M. Contract or Surv. No. Cor.

USDA-FOREST SERVICE

Index

File No. 1563

CORNER RECORD (SEARCH)

(Ref. FSM 7.151.4)

Tract or

Survey No.

Cor. No. N-15

T. 15 S. R. 9 E. R.D. Sisters

County Deschutes

514 COR. of SEC. 15

Merid. WILLAMETTE

N.F. DESCHUTES

State OREGON

COR. of SEC. 1

CORNER DIAGRAM PER LEGEND

DESCRIBE CORNER MONUMENT FOUND

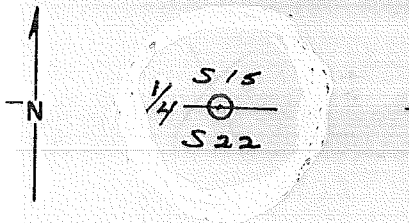

Nothing found

DESCRIBE BEARING TREES OR OTHER OFFICIAL ACCESSORIES FOUND

none

PHOTO IDENTIFICATION DATA

Photo No. _____

Filed At. _____

Object Ident. _____

Ident. By _____

Signature

DESCRIBE CORNER LOCATION RELATIVE TO NEAR-BY FEATURES, ALSO HOW TO REACH CORNER

Take USFS Rd#1536S to Rd#1536-D. Turn right, go to FR-35, turn right to FR-20. Go 0.7 miles. Stop, corner is 100' north of road.

Corner Legend:

Searched for/Not Found

Evidence Found/Accept

Permanent Monument

Signature

Edgar Brown

Title
Surveyor

Division
ORLS 980

Headquarters
Bend

Date
12/80

D-7100-52 (3/79)

CORNER RECORD (PERPETUATION)

MONUMENT DESCRIBE NEW MONUMENT SET, OR WORK DONE TO PRESERVE EXISTING MONUMENT

Set 2 1/2" Aluminum cap on 2 1/2"X30" Aluminum pipe 21" in ground with two stones along side: 8X8X8 and 12X8X6

MONUMENT STAMPED

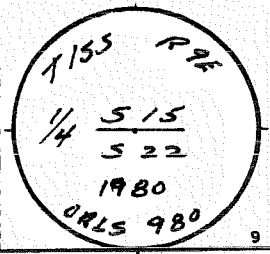

ACCESSORIES DESCRIBE NEW BT'S WITNESS OBJECTS ETC. ESTABLISHED, OR WORK DONE TO PRESERVE EXISTING EVIDENCE

6" P.Pine, N43 1/2°W, 22.0', Scribed 1/4 S15 B.T.
 6" P.Pine, S26°W, 39.2', Scribed 1/4 S22 B.T.
 All B.T.'s have sign 54-4 & 54-3 attached. Set steel post with 54-4 sign, 3' west of monument. Painted red band around bearing trees. Tagged trees w/L.S. 980 washer.

10

Work Done By E.W. Graves Title Surveyor Date 12/80 State Registration No. ORLS 980
 or Agency

PLAT PREPARED OR
 Certified Cor Record Prepared? Yes No Filed At: Deschutes Co. SURVEYOR'S OFFICE Date

11

REMARKS

Witnesses to the above corner: D. Scott
 R. Taylor

12

Index File No. 1563 T. 15 S., R. 9 E., W.M. Tract or Surv. No. Cor. N-15

13

LAND CORNER RECORD

1763

N-17

1. T 15S R 9E No. N-17 Cor. Sec. Mer. Will State Oregon (Rectangular) N. F. Deschutes Dist. Sisters

2. Corner Status

3. Original Description _____ Vol. _____ Page _____ Where Recorded _____

4. Description of Corners: 10-3-1870 Set stone 12x12x8 for cor to Secs 14, 15, 22 & 23 - from which a Pine 40 in. diam. bears N10°E, 44 lks. dist.

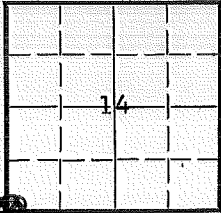

5. Investigation Notes: Found pile of stones, one measuring 12x11x7 ins. above the ground in fair condition with no markings.

7. Photo Identification 7-14-59
Photo No. EG1-51-196
Ident. By: O. Thingvall

P. P. Stump - down snag
piece of snag has
T14SR9E1 on it N13 E
29°

8. Plane Coordinate Position Data
State _____ Zone _____
X _____
Y _____
Estab. By _____
Field Book No. _____
Where Filed _____

From the section line marker between sections 14 & 23 on Rd. 1536, the cor is approximately 2280 ft. west.

9. Evaluation
Authentic _____
Needs Verif. _____ Monument _____
Re-estab. _____ Survey _____
Land Status _____

6. Signed O. Thingvall Title Hwy. Eng. Date 5-28-63

vis: M. HEATH, ST, SO 11/81 PLM BC w/4 NEW BTS & ORIG. STUMP

PERPETUATION RECORD

10. Monument:

Brass Cap on 2 1/2" x 28" S. Pipe RSG 4" 6"
IN MO. of STONES 2' at Base

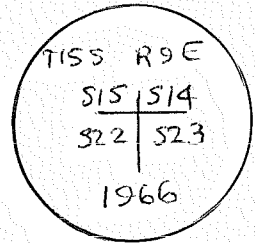

11. Accessories

6" Pine, N35E, 32 lks MKD TISS R9E S14 BT
 5" Pine, N4 1/2 W, 32 ks " TISS R9E S15 BT
 7" Pine, S6 1/2 W, 50 lks " TISS R9E S22 BT
 17" Pine, S60E, 56 lks " TISS R9E S23 BT
 Plus Old Ones

Field Book _____ Page _____

12. Set By _____ Title _____
 License _____ Agency BLM Date 1966

13. Recorded By _____ Volume _____ Page _____
 (Agency) _____
 (Date) _____ (City) _____ (County) _____ (State) _____

14. Remarks:

BT is OK Recd 7/79

USDA-FOREST SERVICE

Index

File No. 1963

CORNER RECORD (SEARCH)

(Ref. FSM 7151.4)

Tract or

Survey No.

53-0444-3-02829

Cor.

No. N-19

T 15S R. 9E

R.D. SISTERS County DESCHUTES

S 1/4 COR OF

Merid. WM

N.F. DESCHUTES State OREGON

SEC 14

CORNER DIAGRAM

DESCRIBE CORNER MONUMENT FOUND

NONE

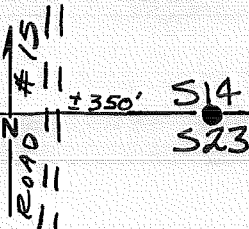

DESCRIBE BEARING TREES OR OTHER OFFICIAL ACCESSORIES FOUND

NONE

PHOTO IDENTIFICATION DATA

Photo No. _____

Filed At. _____

Object Ident. _____

Ident. By _____

Signature

PLANE COORDINATE POSITION DATA

State _____ Zone _____

X _____

Y _____

Estab. By _____

Agency

DESCRIBE CORNER LOCATION RELATIVE TO NEAR-BY FEATURES, ALSO HOW TO REACH CORNER

CORNER IS 300' ± EAST OF RD # 15.

FROM INTERSECTION OF RDS # 15, 1514 TAKE RD # 15 FOR 1/2 MILE.

Signature

RCC

Title

RLS 1632

Division

+

Headquarters

Date

4-24-84

7100-52-(3/68)

5

+

CORNER RECORD (PERPETUATION)

MONUMENT: DESCRIBE NEW MONUMENT SET, OR WORK DONE TO PRESERVE EXISTING MONUMENT

SET STANDARD USFS 2 1/2" X 30" GALV. PIPE & BRASS CAP
 FIRMLY IN GROUND RISING 6" ABOVE NATURAL GROUND
 ERECTED STONE ~~SET~~^{MOUND} AROUND MONUMENT.
 MARKED AS SHOWN

TISS R 9E
 S14
 1/4 ———
 S23
 1984
 PLS 1632

ACCESSORIES: DESCRIBE NEW BT'S WITNESS OBJECTS ETC. ESTABLISHED, OR WORK DONE TO PRESERVE EXISTING EVIDENCE

7" DBH P. PINE BEARS N42°E 66.72 FT. SCRIBED "1/4 S14 BT"
60d NAIL IN NW BASE

9" DBH P. PINE BEARS S62 1/2°E 23.06 FT. SCRIBED "1/4 S23 BT"
60d NAIL IN NE BASE

10

Work Done By: RCC Title: PLS Date: 4/84 State Registration No. 1632
 or Agency

Certified Cor. Record Prepared? Yes No Filed At: DES. CO. SURV. OFFICE Date 3 MAY 1984 11

REMARKS

JH McCLUNG SGT A 14 X 12 X 5 STONE
 NO BT'S

12

Index File No. 1963 T. ISS R. 9E M. WM Tract or Surv. No. 53-0466-3-02829 Cor. N-19 13
 U.S. G.P.O. 1977-725-576/586

Index
File No. 2163

CORNER RECORD (SEARCH)
(Ref. FSM 7151.4)

53-0469-3-02829
Tract or Survey No. _____
Cor. No. N-21

T 15S R. 9E

R.D. SISTERS County DESCHUTES SW COR OF

Merid. W/M

N.F. DESCHUTES State OREGON SEC 13

CORNER DIAGRAM

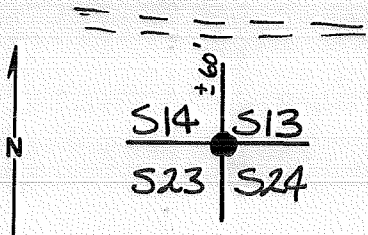

DESCRIBE CORNER MONUMENT FOUND

NONE

DESCRIBE BEARING TREES OR OTHER OFFICIAL ACCESSORIES FOUND

NONE

PHOTO IDENTIFICATION DATA

Photo No. _____
Filed At. _____
Object Ident. _____
Ident. By _____
Signature _____

PLANE COORDINATE POSITION DATA

State _____ Zone _____
X _____
Y _____
Estab. By _____
Agency _____

DESCRIBE CORNER LOCATION RELATIVE TO NEAR-BY FEATURES, ALSO HOW TO REACH CORNER

FROM INTERSECTION OF RDS. 15 & 1514 TAKE RD. 1514 FOR 3000' ± TO CINDERED RD. TO EAST FOLLOW CINDERED RD FOR 800' ± TO CORNER. CORNER LIES ON SOUTH SIDE RD. 60' ±

Signature

RCC

Title

PLS 1632

Division

+

Headquarters

Date

4/24/84

T
CORNER RECORD (PERPETUATION)

MONUMENT: DESCRIBE NEW MONUMENT SET, OR WORK DONE TO PRESERVE EXISTING MONUMENT

SET STANDARD USFS 2 1/2" X 30" GALV. PIPE & BRASS CAP
 FIRMLY IN GROUND RISING 6" ABOVE NATURAL GROUND
 ERECTED STONE ^{MOUND} ~~SET~~ AROUND MONUMENT.
 MARKED AS SHOWN

T155 R9E

S14 | S13

S23 | S24

1984

PLS 1632 9

ACCESSORIES DESCRIBE NEW BT'S WITNESS OBJECTS ETC. ESTABLISHED, OR WORK DONE TO PRESERVE EXISTING EVIDENCE

12" DBH P. PINE BEARS N 41 1/2° W 50.33 FT. SCRIBED "T155 R9E S14 BT"
GOD NAIL IN NE BASE
 12" DBH P. PINE BEARS N 26 1/4° E 82.26 FT. SCRIBED "T155 R9E S13 BT"
GOD NAIL IN WNW BASE
 8" DBH P. PINE BEARS S 42 1/2° E 62.38 FT. SCRIBED "T155 R9E S24 BT"
GOD NAIL IN SW BASE
 8" DBH P. PINE BEARS S 43° W 55.53 FT. SCRIBED "T155 R9E S23 BT"
GOD NAIL IN NW BASE

10

Work Done By RCC Title PLS Date 4/84 State Registration No. 1632
 or Agency

Certified Cor. Record Prepared? Yes No Filed At: DES. CO. SURV. OFFICE Date 3 MAY 1984 11

REMARKS

J.H. McCLONG SET A STONE 15 X 10 X 6
 NO BT'S

S3-0466-3-02829

12

Index File No.

2163

T. 155 R. 9E M. WM

Tract or Surv. No.

Cor. N-21 13
 U.S. G.P.O. 1977-725-576/586

Index
File No. 2363

CORNER RECORD (SEARCH)
(Ref. FSM 7151.4)

53-0446-3-02829
Tract or
Survey No. _____
Cor. No. N-23

T 15S R. 9E

R.D. SISTERS County DESCHUTES S 1/4 OF SEC

Merid. LWM

N.F. DESCHUTES State OREGON 13

CORNER DIAGRAM

DESCRIBE CORNER MONUMENT FOUND

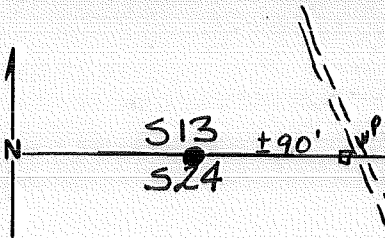

NONE

FOUND SQUARED POST SET BY BROOKS-SCANLON 50' ±
NW OF OUR CORNER

DESCRIBE BEARING TREES OR OTHER OFFICIAL ACCESSORIES FOUND

NONE

PHOTO IDENTIFICATION DATA

Photo No. _____
Filed At. _____
Object Ident. _____
Ident. By _____
Signature

DESCRIBE CORNER LOCATION RELATIVE TO NEAR-BY FEATURES, ALSO HOW TO REACH CORNER

FROM INTERSECTION OF RDS. 15 E 1514 TAKE RD #1514
FOR 3000' ± TO A CINDER RD. TO THE EAST FOLLOW
CINDER RD. IT TURNS INTO A DIRT RD. FOLLOW DIRT RD.
TO POSTED PROPERTY ~~BOUNDARY~~ LINE. CORNER IS 90' ±
WEST OF RD.

PLANE COORDINATE POSITION DATA

State _____ Zone _____
X _____
Y _____
Estob. By _____
Agency

Signature
RCC

Title
PLS1632

Division
+

Headquarters

Date
4/24/84

T
CORNER RECORD (PERPETUATION)

MONUMENT: DESCRIBE NEW MONUMENT SET, OR WORK DONE TO PRESERVE EXISTING MONUMENT

SET STANDARD USFS 2 1/2" X 30" GALV. PIPE & BRASS CAP
 FIRMLY IN GROUND RISING 7" ABOVE NATURAL GROUND
 ERECTED STONE ~~PIPE~~^{MONUMENT} AROUND MONUMENT.
 MARKED AS SHOWN

TISS R9E

1/4 S13

S24

1984

PLS 1632

9

ACCESSORIES : DESCRIBE NEW BT'S WITNESS OBJECTS ETC. ESTABLISHED, OR WORK DONE TO PRESERVE EXISTING EVIDENCE

A 6" P. PINE BEARS N37°E 21.22 FT. SCRIBED "1/4 S13 BT"
60d NAIL IN NW BASE
 A 7" DBH P. PINE BEARS S10 1/2°E 34.00 FT. SCRIBED "1/4 S24 BT"
60d NAIL IN E BASE

10

Work Done By RCC Title PLS Date 4/84 State Registration No. 1632
 or Agency

Certified Cor. Record Prepared? (Yes) No Filed At DES. CO. SURV. OFFICE Date 3 MAY 1984

J.H. McCLUNG SET A STONE 14X12X6
REMARKS

12

Index File No. 2363 T. 155 R. 9E M. W111

Tract or Surv. No. 53-0466-3-02829

Cor. N-23 13
 U.S. G.P.O. 1977-725-576/586

Index
 File No. 2563 CORNER RECORD (SEARCH) Contract or Survey No. 53-0444-3-02829 Cor. No. N-25
 (Ref. FSM 7151.4)
 T 15 S. R. 9 E. R.D. SISTERS County DESCHUTES SE Cor. of
 Merid. Willamette N.F. Deschutes State Oregon Section 13

CORNER DIAGRAM per legend

DESCRIBE CORNER MONUMENT FOUND

FOUND ORIG. 14X12X6 BASALT STONE
 SET FIRMLY IN CENTER OF A RING OF STONE. FOUND NO
 NOTCHES ON STONE. STONE FITS WITH TWO ORIG. LINE
 TREES TO THE SOUTH

DESCRIBE BEARING TREES OR OTHER OFFICIAL ACCESSORIES FOUND

NO G.L.O BTS SET AT THIS CORNER.
 FOUND 5/8" IR SET AT FENCE CORNER BEARS
 N 58°38'18"W 35.86 FT. SET BY G. COOK LS 540

RD NOT SET BY ANY ORIG. EVIDENCE AS G. COOK
 TELLS IT.

DESCRIBE CORNER LOCATION RELATIVE TO NEAR-BY FEATURES, ALSO HOW TO REACH CORNER

TURN WEST OFF CINDER RD. No. ~~1567~~ 1567
 ON DIRT SPUR RD. AFTER CROSSING POSTED
 PROPERTY LINE FOLLOW DIRT SPUR IN A
 NORTHWESTERLY DIRECTION FOR APPROX.
 3/4 OF A MILE ± CORNER LIES WEST OF END OF RD.

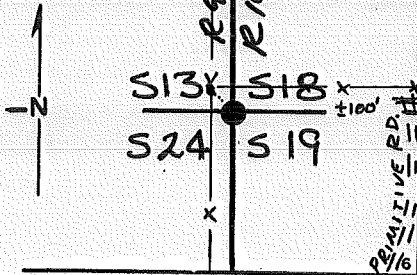

PHOTO IDENTIFICATION DATA

Photo No. _____
 Filed At. _____
 Object Ident. _____
 Ident. By _____
 Signature _____

CORNER LEGEND:

- FS or Unverified
- Contr. Other
- ◊ Searched For/Not Found
- ⊗ ⊗ Evidence Found/Accept.
- ◆ Permanent Mon. Set/Fd.

Searched By: RCC Title PLS 1632 Division _____ Headquarters _____ Date 3-22-84

CORNER RECORD (PERPETUATION)

MONUMENT: DESCRIBE NEW MONUMENT SET, OR WORK DONE TO PRESERVE EXISTING MONUMENT

SET STANDARD USES MONUMENT A 2 1/2" X 30" GALV PIPE WITH A 2 1/2" BRASS CAP FIRMLY IN GROUND ERECTED STONE ^{MOUND} ~~BT'S~~ AROUND MONUMENT. CAP RISES 6" ABOVE NATURAL GROUND

MONUMENT STAMPED

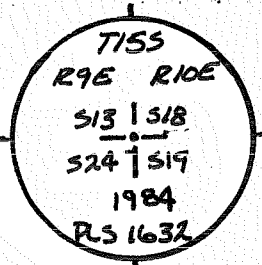

ACCESSORIES: DESCRIBE NEW BT'S WITNESS OBJECTS ETC. ESTABLISHED, OR WORK DONE TO PRESERVE EXISTING EVIDENCE

- 7" DBH P. PINE BEARS N40°15'W 46.80 FT. SCRIBED "TISS R9E S13 BT" ^{60d NAIL IN NE BASE}
- 9" DBH P. PINE BEARS N38°E 57.44 FT. SCRIBED "TISS R10E S18 BT" ^{60d NAIL IN NW BASE}
- 9" DBH P. PINE BEARS S51°15'E 45.08 FT. SCRIBED "TISS R10E S19 BT" ^{60d NAIL IN NE BASE}
- 7" DBH P. PINE BEARS S21°45'W 47.46 FT. SCRIBED "TISS R9E S24 BT" ^{60d NAIL IN SE BASE}

Work Done By: RCC Title: PLS Date: _____ State Registration No. 1632 or Agency: _____
Established or Record Prepared? Yes No Filed At: Desch. Co. Surveyor's Office Date: 3 MAY 1984

History of Surveys, G.L.O., etc. SET A STONE 14 X 12 X 6 JH. McCLUNG
NO BT'S

53-0469-3-02829

Index
File No. 2165
T 155 R. 9E
Merid. WM

CORNER RECORD (SEARCH)
(Ref. FSM 7151.4)

Tract or Survey No. _____
Cor. No. P-21
R.D. SISTERS County DESCHUTES E 1/4 OF
N.F. DESCHUTES State OREGON S 23

CORNER DIAGRAM

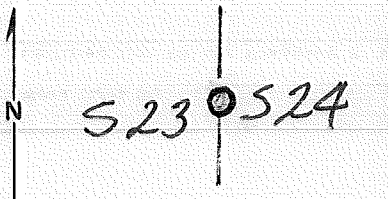

DESCRIBE CORNER MONUMENT FOUND

NONE

DESCRIBE BEARING TREES OR OTHER OFFICIAL ACCESSORIES FOUND

NONE

PHOTO IDENTIFICATION DATA

Photo No. _____
Filed At. _____
Object Ident. _____
Ident. By _____
Signature

PLANE COORDINATE POSITION DATA

State _____ Zone _____
X _____
Y _____
Estab. By _____
Agency

DESCRIBE CORNER LOCATION RELATIVE TO NEAR-BY FEATURES, ALSO HOW TO REACH CORNER

WEST FROM RD # 1551 APPROX 1/4 OF A MILE TO SCARCH AREA.

Signature RCC

Title PLS 1632

Division _____

Headquarters _____

Date 11-83

CORNER RECORD (PERPETUATION)

MONUMENT: DESCRIBE NEW MONUMENT SET, OR WORK DONE TO PRESERVE EXISTING MONUMENT

SET LATH MARKED APPROX 1/4 COR.

9

ACCESSORIES : DESCRIBE NEW BT'S WITNESS OBJECTS ETC. ESTABLISHED, OR WORK DONE TO PRESERVE EXISTING EVIDENCE

—

10

Work Done By RCC JRC Title PLS Date 11-83 State Registration No. OR-1632
or Agency

Certified Cor. Record Prepared Yes No Filed At: DES. CO. SURV. OFFICE Date 13 June 1984

REMARKS

SEARCH AREA IN A 300' RADIUS NO FIND.
J.H. McCLUNG SET A STONE 14X11X7 NO BT'S

12

Index File No. 2165 T. 155 R. 9E M. 6M Tract or Surv. No. 53-0466-3-0287 Cor. P-21

13

D-7100-52d (10/78)
USDA-FOREST SERVICE

Index
File No. 2565 CORNER RECORD (SEARCH) (Ref. FSM 7151.4) Contract or Survey No. CS#3-2 Cor. No. P-25
T 15 S. R. 9 E. R.D. SISTERS County DESCHUTES 1/4 Cor./of
Merid. WILLAMETTE N.F. DESCHUTES State OREGON Section 24/19

SEE: P-01 T. 15 S., R. 10 E. W.M.

BC by Clark (1984)

2565

P-25

Index File No. 1767

T. 15 S. R. 9

Merid. WILLAMETTE

CORNER RECORD (SEARCH)

(Ref. FSM 7.151.4)

E. R.D. SISTERS County DESCHUTES

N.F. DESCHUTES State OREGON

Tract or Survey No.

Cor. No. R-17

SE COR. of SEC. 22

NW COR. of SEC. 26

CORNER DIAGRAM PER LEGEND

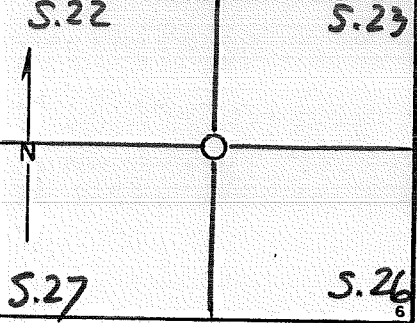

DESCRIBE CORNER MONUMENT FOUND

SF/NF

DESCRIBE BEARING TREES OR OTHER OFFICIAL ACCESSORIES FOUND

PHOTO IDENTIFICATION DATA

Photo No. _____
 Filed At. _____
 Object Ident. _____
 Ident. By _____
Signature

DESCRIBE CORNER LOCATION RELATIVE TO NEAR-BY FEATURES, ALSO HOW TO REACH CORNER

FD. SIGN BD. "S.347" ON ROAD 1551-D
FD. POSSIBLE LINE TREE ~
OLD LOGGING & RECENT THINNING IN AREA

Corner Legend:

- Searched for/Not Found
- Evidence Found/Accept.
- Permanent Monument

Signature J. PERCIVAL

Title ST

Division

Headquarters SO

Date 1/81 D-7100-52 (3/79)

CORNER RECORD (PERPETUATION)

MONUMENT. DESCRIBE NEW MONUMENT SET, OR WORK DONE TO PRESERVE EXISTING MONUMENT

MONUMENT STAFFED

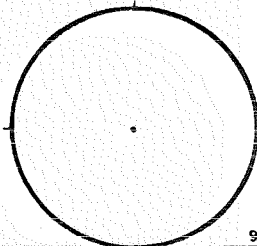

ACCESSORIES DESCRIBE NEW BT'S WITNESS OBJECTS ETC. ESTABLISHED, OR WORK DONE TO PRESERVE EXISTING EVIDENCE

Work Done By _____ Title _____ Date _____ State Registration No. or Agency _____
PLAT PREPARED OR
Certified Cor. Record Prepared ? Yes No Filed At: Co. SURVEYOR'S OFFICE Date

REMARKS

Index File No. 1767 T. 15 S., R. 9 E., W.M. Tract or Surv. No. Cor. R-17

Index File No. _____
 T 15S R. 9E R.D. SISTERS County DESCHUTES Cor. No. R-19
 Merid. WILLAMETTE N.F. DESCHUTES State OREGON 5/4 of Sec. 23
N/4 of Sec. 26

CORNER DIAGRAM

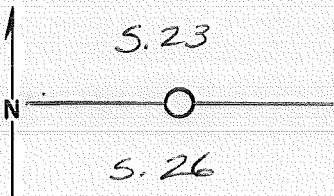

DESCRIBE CORNER MONUMENT FOUND

SP NF

DESCRIBE BEARING TREES OR OTHER OFFICIAL ACCESSORIES FOUND

PHOTO IDENTIFICATION DATA

Photo No. _____
 Filed At. _____
 Object Ident. _____
 Ident. By _____
Signature

DESCRIBE CORNER LOCATION RELATIVE TO NEAR-BY FEATURES, ALSO HOW TO REACH CORNER

LOGGED OVER HEAVILY

PLANE COORDINATE POSITION DATA

State _____ Zone _____
 X _____
 Y _____
 Estab. By _____
Agency

Signature R. TAYLOR Title LSIT Division S.D. Headquarters DES. N.F./BEND Date 8-82 FS-7100-52 (3/68)

CORNER RECORD (PERPETUATION)

MONUMENT: DESCRIBE NEW MONUMENT SET, OR WORK DONE TO PRESERVE EXISTING MONUMENT

9

ACCESSORIES : DESCRIBE NEW BT's WITNESS OBJECTS ETC. ESTABLISHED, OR WORK DONE TO PRESERVE EXISTING EVIDENCE

10

Work Done By _____ Title _____ Date _____ State Registration No. or Agency _____

Certified Cor. Record Prepared ? Yes No Filed At: _____ Date _____ 11

REMARKS

12

Index File No.

T. 155 R. 9E M. WM.

Tract or Surv. No.

Cor. R-19

13

CORNER RECORD (SEARCH)

(Ref. FSM 7151.4)

53-0966-3-02829

Index
File No. 2167
T 155 R. 9E
Merid. WM

Tract or
Survey No. _____
Cor.
No. P-21
NW COR OF
S 25

R.D. SISTERS County DESCHUTES
N.F. DESCHUTES State OREGON

CORNER DIAGRAM

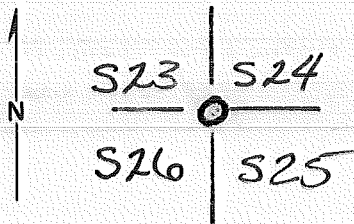

DESCRIBE CORNER MONUMENT FOUND

1' SFNF

DESCRIBE BEARING TREES OR OTHER OFFICIAL ACCESSORIES FOUND

SFNF

PHOTO IDENTIFICATION DATA

Photo No. _____
Filed At. _____
Object Ident. _____
Ident. By _____
Signature

DESCRIBE CORNER LOCATION RELATIVE TO NEAR-BY FEATURES, ALSO HOW TO REACH CORNER

SEARCH AREA FALLS ON THE ^{NORTH} SIDE OF A
SMALL ROCK KNOB. TURN WEST OFF
RD # 1551 ON DIRT SPUR. ~~THE~~
~~THE END~~ THEN TURN IN A N.W. DIRECTION
TO THE END. CORNER LIES 200'± WEST

PLANE COORDINATE POSITION DATA

State _____ Zone _____
X _____
Y _____
Estab. By _____
Agency

Signature
RCC

Title
PLS 1632

Division

Headquarters

Date
11-83

FS-7100-52 (3/68)

CORNER RECORD (PERPETUATION)

MONUMENT: DESCRIBE NEW MONUMENT SET, OR WORK DONE TO PRESERVE EXISTING MONUMENT

SET 4' LATH IN APPROX. SEARCH AREA.

ACCESSORIES : DESCRIBE NEW BT'S WITNESS OBJECTS ETC. ESTABLISHED, OR WORK DONE TO PRESERVE EXISTING EVIDENCE

—

Work Done By. BOB JAC Title PLS NC Date 11-83 State Registration No. 1632
or Agency
Certified Cor. Record Prepared? Yes No Filed At: DES. CO. SURV. OFFICE Date 13 June 1984

REMARKS

J.H. McCLUNG SET A STONE 15 X 13 X 11 NO BT'S

Index File No. 2167 T. 155 R. 95 M. WM Tract or Surv. No. 53-0466-3-02829 Cor. R-21

Index
File No. 2367

CORNER RECORD (SEARCH)
(Ref. FSM 7151.4)

Tract or
Survey No. _____
Cor.
No. R-23

T 15S R. 9E R.D. SISTERS County DESCHUTES 5/4 of Sec. 24
Merid. WM. N.F. DESCHUTES State OR. N/4 cor. of Sec. 25

CORNER DIAGRAM

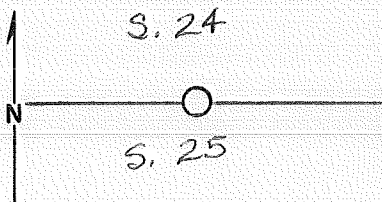

DESCRIBE CORNER MONUMENT FOUND SFNF

PHOTO IDENTIFICATION DATA

Photo No. _____
Filed At. _____
Object Ident. _____
Ident. By _____
Signature

DESCRIBE BEARING TREES OR OTHER OFFICIAL ACCESSORIES FOUND

PLANE COORDINATE POSITION DATA

State _____ Zone _____
X _____
Y _____
Estab. By _____
Agency

DESCRIBE CORNER LOCATION RELATIVE TO NEAR-BY FEATURES, ALSO HOW TO REACH CORNER

LOGGED OVER HEAVILY

Signature R. TAYLOR Title LSHT Division S.O. Headquarters DES. N.F./BEND Date 8-82 FS-7100-52 (3/68)

CORNER RECORD (PERPETUATION)

MONUMENT : DESCRIBE NEW MONUMENT SET, OR WORK DONE TO PRESERVE EXISTING MONUMENT

9

ACCESSORIES : DESCRIBE NEW BT'S WITNESS OBJECTS ETC. ESTABLISHED, OR WORK DONE TO PRESERVE EXISTING EVIDENCE

10

Work Done By _____ Title _____ Date _____ State Registration No. or Agency _____

Certified Cor. Record Prepared ? Yes No Filed At: _____ Date _____

11

REMARKS

12

Index File No. 2367 T. 155 R. 9E M. WM Tract or Surv. No. Cor. R-23

13

Index File No. 2567 CORNER RECORD (SEARCH) Contract or Survey No. 53-0444-3-02829 Cor. No. R-25
 (Ref. FSM 7151.4) Merid. Willamette N.F. Deschutes State Oregon Section 25
 T 15 S. R. 9 E. R.D. SISTERS County DESCHUTES NE Cor. of

CORNER DIAGRAM per legend

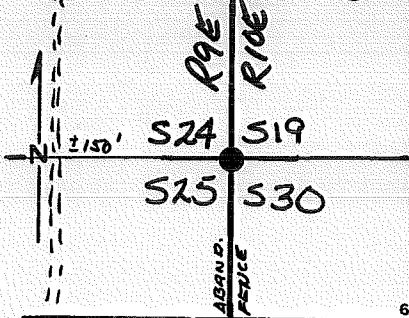

DESCRIBE CORNER MONUMENT FOUND

FOUND 15X12X5 BASALT STONE SET FIRMLY IN A RING OF STONE. WIRE BRUSHING OF STONE REVELED TWO NOTCHES ON SOUTH EDGE

DESCRIBE BEARING TREES OR OTHER OFFICIAL ACCESSORIES FOUND

FD. 17" PINE BT DEAD & DOWN TREE HAS BEEN TRANSPORTED S78°E 70 FT. STONE LIES 3.0' EAST OF OLD FENCE LINE.

PHOTO IDENTIFICATION DATA

Photo No. _____
 Filed At. _____
 Object Ident. _____
 Ident. By _____
 Signature _____

DESCRIBE CORNER LOCATION RELATIVE TO NEAR-BY FEATURES, ALSO HOW TO REACH CORNER

TURN LEFT OFF CINDER RD. 1567 ONTO CINDER RD. # UNKNOWN FOLLOW CINDER RD. FOR 1/2 MILE ± TO LOCATION TAG ON EAST SIDE RD. CORNER IS VISIBLE FROM RD.

CORNER LEGEND:

- FS or Unverified
- Contr. Other
- Searched For/Not Found
- Evidence Found/Accept.
- Permanent Mon. Set/Fd.

Searched By: RCC Title PLS 1632 Division _____ Headquarters _____ Date 3-20-84

CORNER RECORD (PERPETUATION)

MONUMENT: DESCRIBE NEW MONUMENT SET, OR WORK DONE TO PRESERVE EXISTING MONUMENT

SET STANDARD USFS 2 1/2" X 30" GALV. PIPE
 WITH A 2 1/2" BRASS CAP FIRMLY IN GROUND
 ERECTED STONE MOUND AROUND MONUMENT
 FLUSH WITH TOP OF MONUMENT; CAP LSG. 4"

MONUMENT STAMPED

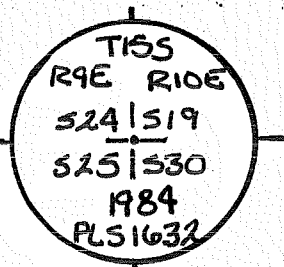

ACCESSORIES: DESCRIBE NEW BT'S WITNESS OBJECTS ETC. ESTABLISHED, OR WORK DONE TO PRESERVE EXISTING EVIDENCE

A 5" DBH P. PINE BEARS N56°W 11.61 FT. SCRIBED "TISS R9E 524 BT"
60d NAIL IN SW BASE

A 9" DBH P. PINE BEARS N03°30'E 16.50 FT. SCRIBED "TISS R10E 519 BT"
60d NAIL IN W BASE

A 7" DBH P. PINE BEARS S24°E 10.96 FT. SCRIBED "TISS R10E 530 BT"
60d NAIL IN WSW BASE

A 6" DBH P. PINE BEARS S36°30'W 33.68 FT. SCRIBED "TISS R9E 525 BT"
60d NAIL IN WNW BASE

Work Done By: RCC Title: PLS Date: 3/84 State Registration No. 1632
 or Agency: _____
 Platified or Record Prepared? Yes No Filed At: DESCH. Co. Surveyor's Office Date: 3 MAY 1984

History of Surveys, G.L.O., etc.
J.H. McCLUNG SET A STONE 15X12X5 & A 15" PINE BT
BEARS N68°W 35 LKS

Index File No. 2567 T. 15 S., R. 9 E., W.M. Contract or Surv. No. 53-0466-3-02829 R-25
 Cor. PLS 1632

Index
 File No. 2169
 T 15S R. 9E
 Merid. WM

CORNER RECORD (SEARCH)
 (Ref. FSM 7151.4)

53-0456-3-02729
 Tract or
 Survey No. _____
 Cor.
 No. T-21
E/A COR. of
SEC. 216

R.D. SISTERS County DESCHUTES
 N.F. DESCHUTES State OREGON

CORNER DIAGRAM



DESCRIBE CORNER MONUMENT FOUND

SFNF

DESCRIBE BEARING TREES OR OTHER OFFICIAL ACCESSORIES FOUND

SFNF

PHOTO IDENTIFICATION DATA

Photo No. _____
 Filed At. _____
 Object Ident. _____
 Ident. By _____
Signature

PLANE COORDINATE POSITION DATA

State _____ Zone _____
 X _____
 Y _____
 Estab. By _____
Agency

DESCRIBE CORNER LOCATION RELATIVE TO NEAR-BY FEATURES, ALSO HOW TO REACH CORNER

SEARCH AREA FALLS ON EAST ~~OF~~ EDGE
 OF CLEAR CUT EAST OF DIRT SPUR. RD.

Signature
PCC

Title
PLS 1632

Division

Headquarters

Date
11-83

FS-7100-52 (3/68)

CORNER RECORD (PERPETUATION)

MONUMENT: DESCRIBE NEW MONUMENT SET, OR WORK DONE TO PRESERVE EXISTING MONUMENT

SET 4' LATH & PINK RIBBON

ACCESSORIES : DESCRIBE NEW BT'S WITNESS OBJECTS ETC. ESTABLISHED, OR WORK DONE TO PRESERVE EXISTING EVIDENCE

—

Work Done By. BCC Title PLS Date 11-83 State Registration No. 1632
or Agency
Certified Cor. Record Prepared Yes No Filed At: DES. CO. SURV. OFFICE Date 13 June 1984

REMARKS

J.H. McCLUNG SET A STONE 18 X 16 X 12
SEARCH IN A 300' RADIUS APPEARS TO HAVE BEEN
LOGGED IN THE PAST.

Index File No. 2169 T. 155 R. 9E M. W477 Tract or Surv. No. Cor. T-21

Index File No. 2569 CORNER RECORD (SEARCH) Contract or Survey No. 53-0449-3-02829 Cor. T-25
 (Ref. FSM 7151.4) T 15 S. R. 9 E. R.D. SISTERS County DESCHUTES No. 157
 Merid. Willamette N.F. Deschutes State Oregon Section 25 E 1/4 Cor. of

CORNER DIAGRAM per Legend



DESCRIBE CORNER MONUMENT FOUND

NONE

DESCRIBE BEARING TREES OR OTHER OFFICIAL ACCESSORIES FOUND

NONE

PHOTO IDENTIFICATION DATA

Photo No. _____
 Filed At. _____
 Object Ident. _____
 Ident. By _____
 Signature _____

DESCRIBE CORNER LOCATION RELATIVE TO NEAR-BY FEATURES, ALSO HOW TO REACH CORNER

CORNER LIES SOUTH OF POLE CREEK DITCH
 500' ± ~~FROM~~ ^{OFF} RD. 1567F WHERE IT INTERSECTS
 DIRT RD. FOLLOW DIRT RD. WHERE I N MAKES
 A TURN TOWARDS THE WEST FOLLOW CUTTING LINE
 TO POLE CREEK DITCH

CORNER LEGEND:

- FS or Unverified
- Contr. Other
- ◇ Searched For/Not Found
- ⊗ ⊗ Evidence Found/Accept.
- ◆ Permanent Mon. Set/Fd.

Searched By: RCC Title PLS 1632 Division _____ Headquarters _____ Date 3-23-84

CORNER RECORD (PERPETUATION)

MONUMENT: DESCRIBE NEW MONUMENT SET, OR WORK DONE TO PRESERVE EXISTING MONUMENT

SET STANDARD USFS 2 1/2" X 30" GALV PIPE & BRASS CAP
FIRMLY IN GROUND RISING 11" ABOVE NATURAL
GROUND ERECTED STONE ^{MOUND} ~~BEING~~ AROUND MONUMENT

MONUMENT STAMPED

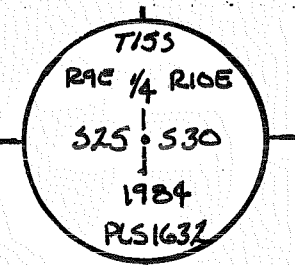

ACCESSORIES: DESCRIBE NEW BT'S WITNESS OBJECTS ETC. ESTABLISHED, OR WORK DONE TO PRESERVE EXISTING EVIDENCE

2" DBH P.PINE BEARS N52°30'W 22.63 FT SCRIBED "1/4 525 BT"
^{60° NAIL IN SW BASE}
2" DBH P.PINE BEARS N18°E 21.77 FT SCRIBED "1/4 530 BT"
^{60° NAIL IN SE BASE}

Work Done By PCC Title PLS Date _____ State Registration No. 1632
or Agency _____
Certified Cor. Record Prepared Yes No Filed At: DESO Co. Surveyor's Office Date 3 MAY 1984

History of Surveys, G.L.O., etc. J.H. McCLUNG IN 1870 SET A STONE 14X10X6
NO BT'S SET

Index File No. 2569 T. 15 S., R. 9 E., W.M. Contract 53-0466-3-02829 or Surv. No. T-25
Cor. 13

Index File No. 0571

CORNER RECORD (SEARCH)

Tract or Survey No. _____

Cor. No. V-5

T 15S, R. 9E.

R.D. SISTERS

County DESCHUTES

Sec Cor _____

Merid. Will

N.F. DESCHUTES

State OREGON

CORNER DIAGRAM

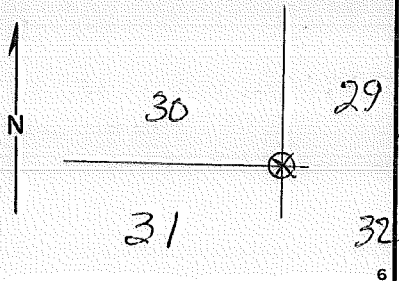

DESCRIBE CORNER MONUMENT FOUND

Stone 10" diameter 6" high
No Markings

DESCRIBE BEARING TREES OR OTHER OFFICIAL ACCESSORIES FOUND

B.T. is 18" Fir, N39°E, dist 22'
Only One BT

PHOTO IDENTIFICATION DATA

Photo No. _____
Filed At. _____
Object Ident. _____
Ident. By _____
Signature

PLANE COORDINATE POSITION DATA

State _____ Zone _____
X _____
Y _____
Estab. By _____
Agency

Signature
F. Chain

Title
Sr. Forest Worker

Division _____

Headquarters _____

Date

6-25-61

7100-52

REV. 65 5

CORNER RECORD (PERPETUATION)

MONUMENT: DESCRIBE NEW MONUMENT SET, OR WORK DONE TO PRESERVE EXISTING MONUMENT

9

ACCESSORIES DESCRIBE NEW BT'S WITNESS OBJECTS ETC. ESTABLISHED, OR WORK DONE TO PRESERVE EXISTING EVIDENCE

10

Work Done By _____ Title _____ Date _____ State Registration No. or Agency _____

Certified Cor. Record Prepared? Yes No Filed At: _____ Date _____

11

REMARKS

12

Index File No. 0571 T. 15 R. 9 M. Tract or Surv. No. Cor. V-5 13

Index
File No. 0771

CORNER RECORD (SEARCH)

(Ref. FSM 7151.4)

Tract or
Survey No. _____Cor.
No. V-7T 15 S R. 9 ER.D. Sisters County Deschutess/a Cor. S. 29Merid. W.M.N.F. Deschutes State OregonN/A Cor. S. 32

CORNER DIAGRAM

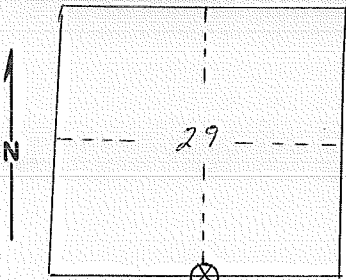

DESCRIBE CORNER MONUMENT FOUND

DESCRIBE BEARING TREES OR OTHER OFFICIAL ACCESSORIES FOUND

P. pine 31" dia. bears $S 24^{\circ} E$ $18^{\frac{8}{16}}$
 scribing not legible, but I believe this to be
 a original B.T.

PHOTO IDENTIFICATION DATA

Photo No. _____

Filed At. _____

Object Ident. _____

Ident. By _____

Signature

PLANE COORDINATE POSITION DATA

State _____ Zone _____

X _____

Y _____

Estab. By _____

Agency

DESCRIBE CORNER LOCATION RELATIVE TO NEAR-BY FEATURES, ALSO HOW TO REACH CORNER

metal post on white fir 3" dia.
 corner bears $S 10^{\circ} E$ $47'$

Signature

Chester M. Beil

Title

Forester

Division

Headquarters

D-5

Date

11/26/52

7100-52-(3/68)

5

CORNER RECORD (PERPETUATION)

MONUMENT : DESCRIBE NEW MONUMENT SET, OR WORK DONE TO PRESERVE EXISTING MONUMENT

ACCESSORIES : DESCRIBE NEW BT'S WITNESS OBJECTS ETC. ESTABLISHED, OR WORK DONE TO PRESERVE EXISTING EVIDENCE

Work Done By _____ Title _____ Date _____ State Registration No. or Agency _____
Certified Cor. Record Prepared ? Yes No Filed At: _____ Date _____

REMARKS

Index File No. 0771 T. 155 R. 9E M.

Tract or Surv. No.

Cor. V-7

Index File No. 1771

CORNER RECORD (SEARCH)

(Ref. FSM 7151.4)

Tract or Survey No. _____ Cor. No. V-17

T 15 S R. 9 E R.D. Sisters County Deschutes SE Cor. S, 27

Merid. W.M. N.F. Deschutes State Oregon NW Cor. S, 35

CORNER DIAGRAM

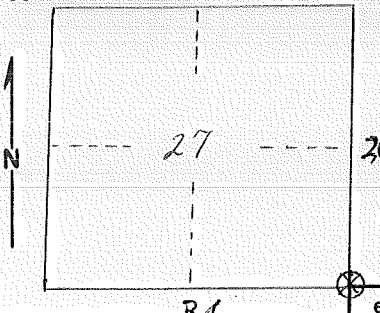

DESCRIBE CORNER MONUMENT FOUND

DESCRIBE BEARING TREES OR OTHER OFFICIAL ACCESSORIES FOUND

P. pine 20" dia bears N 55° W 130' MKD. SR 9E BT
 on SE EDGE of SPUR ROAD in DRAW

PHOTO IDENTIFICATION DATA

Photo No. _____
 Filed At. _____
 Object Ident. _____
 Ident. By _____
 Signature _____

VIS: R. OMAN, PLS, SO 11/81

DESCRIBE CORNER LOCATION RELATIVE TO NEAR-BY FEATURES, ALSO HOW TO REACH CORNER

P. pine 21" dia corner bears S 55° E 130'
 metal post -
 section line marker bet. 26/25 on pole creek rd #153
 located 10' from corner

PLANE COORDINATE POSITION DATA

State _____ Zone _____
 X _____
 Y _____
 Estab. By _____
 Agency _____

Signature Chester M. Beil

Title Forester

Division D-5

Headquarters _____

Date Nov. 7, 1953

7100-52-(3/68)

(3R)

CORNER RECORD (PERPETUATION)

MONUMENT : DESCRIBE NEW MONUMENT SET, OR WORK DONE TO PRESERVE EXISTING MONUMENT

9

ACCESSORIES : DESCRIBE NEW BT'S WITNESS OBJECTS ETC. ESTABLISHED, OR WORK DONE TO PRESERVE EXISTING EVIDENCE

10

Work Done By _____ Title _____ Date _____ State Registration No. or Agency _____

Certified Cor. Record Prepared ? Yes No Filed At: _____ Date _____

11

REMARKS

Index File No. 1771 T. 15 S. R. 9 E M. Tract or Surv. No. Cor. V-17

12

13

Index
File No. _____

CORNER RECORD (SEARCH)
(Ref. FSM 7151.4)

Tract or
Survey No. _____

Cor.
No. V-19

T 155 R. 9E

R.D. SISTERS County DESCHUTES

N 1/4 Cor. of Sec. 35

Merid. WM

N.F. DESCHUTES State OREGON

S 1/4 Cor. of Sec. 26,

CORNER DIAGRAM

DESCRIBE CORNER MONUMENT FOUND SFNF

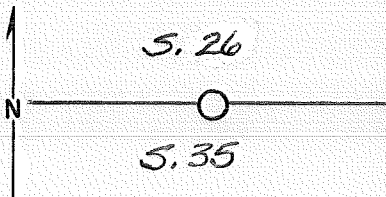

DESCRIBE BEARING TREES OR OTHER OFFICIAL ACCESSORIES FOUND

PHOTO IDENTIFICATION DATA

Photo No. _____
Filed At. _____
Object Ident. _____
Ident. By _____
Signature

DESCRIBE CORNER LOCATION RELATIVE TO NEAR-BY FEATURES, ALSO HOW TO REACH CORNER

AREA LOGGED OVER HEAVILY

PLANE COORDINATE POSITION DATA

State _____ Zone _____
X _____
Y _____
Estab. By _____
Agency

Signature
R. TAYLOR

Title
L.S.I.T.

Division
S.O.

Headquarters
DES. N.F. - BEND

Date
8-82

FS-7100-52 (3/68)

CORNER RECORD (PERPETUATION)

MONUMENT : DESCRIBE NEW MONUMENT SET, OR WORK DONE TO PRESERVE EXISTING MONUMENT

9

ACCESSORIES : DESCRIBE NEW BT'S WITNESS OBJECTS ETC. ESTABLISHED, OR WORK DONE TO PRESERVE EXISTING EVIDENCE

10

Work Done By _____ Title _____ Date _____ State Registration No. or Agency _____

Certified Cor. Record Prepared ? Yes No Filed At: _____ Date _____

11

REMARKS

12

Index File No. T. 15S R. 9E M. WM Tract or Surv. No. Cor. K-19

13

Index File No. 2171 CORNER RECORD (SEARCH) Contract or Survey No. 53-0446-3-02829 Cor. No. V-21
 (Ref. FSM 7151.4)
 T 15 S. R. 9 E. R.D. SISTERS County DESCHUTES SW Cor. of
 Merid. Willamette N.F. Deschutes State Oregon Section 25

CORNER DIAGRAM, per legend

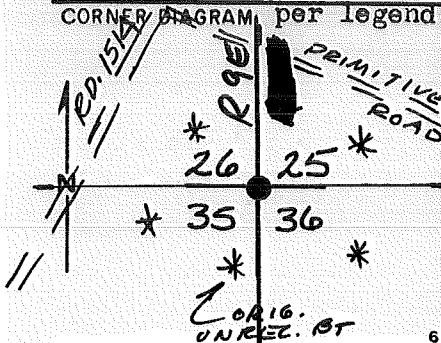

DESCRIBE CORNER MONUMENT FOUND

ORIGINAL 15X7X6 BASALT STONE WITH ONE NOTCH ON SOUTH SIDE.

DESCRIBE BEARING TREES OR OTHER OFFICIAL ACCESSORIES FOUND

FOUND UNRECORDED BEARING TREE.

PHOTO IDENTIFICATION DATA

Photo No. _____
 Filed At. _____
 Object Ident. _____
 Ident. By _____
 Signature _____

DESCRIBE CORNER LOCATION RELATIVE TO NEAR-BY FEATURES, ALSO HOW TO REACH CORNER

CORNER LIES EAST OF RD# 1514 VISIBLE FROM ROAD, ± 250' EAST AND ± 125' SOUTH OF PRIMITIVE ROAD.

CORNER LEGEND:

- FS or Unverified
- Contr. Other
- Searched For/Not Found
- Evidence Found/Accept.
- Permanent Mon. Set/Fd.

Searched By: RCC

Title PLS 1632

Division _____

Headquarters _____

Date _____

4-84

2

3

4

5

CORNER RECORD (PERPETUATION)

MONUMENT: DESCRIBE NEW MONUMENT SET, OR WORK DONE TO PRESERVE EXISTING MONUMENT

SET STANDARD USFS 2 1/2" X 30" GALV. PIPE &
 3/2 BRASS CAP FIRMLY IN GROUND RISING
 6" ABOVE NATURAL GROUND. ERECTED STONE
~~MONUMENT~~ AROUND MONUMENT.

MONUMENT STAMPED

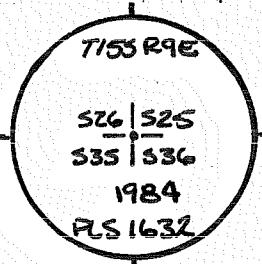

ACCESSORIES: DESCRIBE NEW BT'S WITNESS OBJECTS ETC. ESTABLISHED, OR WORK DONE TO PRESERVE EXISTING EVIDENCE

8" DBH P. PINE BEARS N 47° W 45.35 FT. SCRIBED TISS R9E 526 BT
60d NAIL IN SW BASE
 10" DBH P. PINE BEARS N 78° 15' E 46.47 FT. SCRIBED TISS R9E 525 BT
60d NAIL IN N. BASE
 7" DBH P. PINE BEARS S 18° 45' E 51.07 FT. SCRIBED TISS R9E 536 BT
60d NAIL IN W. BASE
 24" DBH P. PINE BEARS S 19° W 20.62 FT. SCRIBED TISS R9E 535 BT
60d NAIL IN E. BASE

Work Done By RCC Title PLS 1632 Date 4-84 State Registration No. OR-1632
 or Agency
 Certified or Record Prepared? Yes No Filed At: DESEH. Co. Surveyor's Office Date 3 MAY 1984

History of Surveys, G.L.O., etc.
JH McCLONG SET A STONE 15X7X6 IN 1870

Index File No. 2171 T. 15 S., R. 9 E., W.M. Contract or Surv. No. V-21
 SW Cor. SW

Index
File No. 2371

CORNER RECORD (SEARCH)
(Ref. FSM 7151.4)

Tract or
Survey No. _____
Cor. No. V-23

T 155 R. 9E R.D. SISTERS County DESCHUTES N 1/4 Cor. of Sec. 36
Merid. WM N.F. DESCHUTES State OREGON S 1/4 Cor. of Sec. 25,

CORNER DIAGRAM

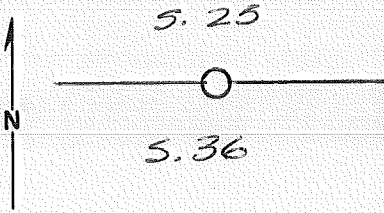

DESCRIBE CORNER MONUMENT FOUND SFNF

DESCRIBE BEARING TREES OR OTHER OFFICIAL ACCESSORIES FOUND

PHOTO IDENTIFICATION DATA

Photo No. _____
Filed At. _____
Object Ident. _____
Ident. By _____
Signature

DESCRIBE CORNER LOCATION RELATIVE TO NEAR-BY FEATURES, ALSO HOW TO REACH CORNER

AREA LOGGED OVER HEAVILY

PLANE COORDINATE POSITION DATA

State _____ Zone _____
X _____
Y _____
Estab. By _____
Agency

Signature R. TAYLOR Title LS. I.T. Division S.O. Headquarters DES. N.F. - BEND Date 8-82 FS-7100-52 (3/68)

CORNER RECORD (PERPETUATION)

MONUMENT : DESCRIBE NEW MONUMENT SET, OR WORK DONE TO PRESERVE EXISTING MONUMENT

9

ACCESSORIES : DESCRIBE NEW BT'S WITNESS OBJECTS ETC. ESTABLISHED, OR WORK DONE TO PRESERVE EXISTING EVIDENCE

10

Work Done By _____ Title _____ Date _____ State Registration No. or Agency _____

Certified Cor. Record Prepared ? Yes No Filed At: _____ Date _____

11

REMARKS

12

Index File No. *2371 T. 155 R. 9E* M. *WM* Tract or Surv. No. Cor. *V-23*

13

Index
File No. 2571

CORNER RECORD (SEARCH)
(Ref. FSM 7151.4)

Contract or
Survey N^o. 53-0444-3-02829

Cor.
No. V-25

T 15 S. R. 9 E. R.D. SISTERS County DESCHUTES NE Cor. of
Merid. Willamette N.F. Deschutes State Oregon Section 36

CORNER DIAGRAM per legend

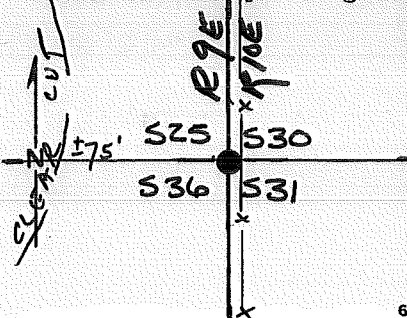

DESCRIBE CORNER MONUMENT FOUND

ORIGINAL BEARING TREE DEAD
EDOWN FOUND ORIG. STONE 6 FT. ± SOUTH OF
TRUE POSITION, ± 2 ft. WEST OF FENCE.

DESCRIBE BEARING TREES OR OTHER OFFICIAL ACCESSORIES FOUND

ORIGINAL BEARING TREE DEAD & DOWN

PHOTO IDENTIFICATION DATA

Photo No. _____
Filed At. _____
Object Ident. _____
Ident. By _____
Signature

DESCRIBE CORNER LOCATION RELATIVE TO NEAR-BY FEATURES, ALSO HOW TO REACH CORNER

FROM RD. 1567E TRUN EAST ON SECOND
SPUR # UNKNOWN TO THE EAST FOR BETTER
THAN A 1/4 MILE CORNER LIES IN NORTH SOUTH
FENCE LINE & EAST SIDE OF A CLEAR CUT.

CORNER LEGEND:

- FS or Unverified
- Contr. Other
- ◊ Searched For/Not Found
- ⊗ ⊗ Evidence Found/Accept.
- ◆ Permanent Mon. Set/Fd.

Searched By: RCC

Title PLS1632

Division _____

Headquarters _____

Date 3-15-84

CORNER RECORD (PERPETUATION)

MONUMENT: DESCRIBE NEW MONUMENT SET, OR WORK DONE TO PRESERVE EXISTING MONUMENT

SET STANDARD USFS 2 1/2" x 30" GALV PIPE &
 2 1/2" BRASS CAP FIRMLY IN GROUND RISING 7"
 ABOVE NATURAL GROUND ERECTED STONE ^{COLLAR} ~~MONUMENT~~
 AROUND MONUMENT.

MONUMENT STAMPED

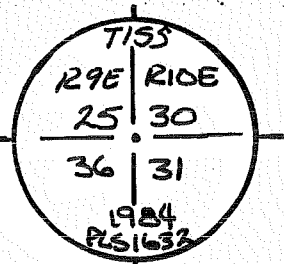

ACCESSORIES: DESCRIBE NEW BT'S WITNESS OBJECTS ETC. ESTABLISHED, OR WORK DONE TO PRESERVE EXISTING EVIDENCE

9" DBH P. PINE BEARS N28°W 25.73 FT SCRIBED T155 R9E S25 BT
60d NAIL IN NE BASE
 7" DBH P. PINE BEARS N35°30'E 11.14 FT. SCRIBED T155 R10E S30 BT
60d NAIL IN ESE BASE
 10" DBH P. PINE BEARS S25°E 21.42 FT. SCRIBED T155 R10E S31 BT
60d NAIL IN SW BASE
 9" DBH P. PINE BEARS S53°15'W 7.01 FT SCRIBED T155 R9E S36 BT
60d NAIL IN SE BASE

Work Done By RCC Title PLS 1632 Date 3-15-84 State Registration No. OR-1632
 or Agency
 Plat of Cor. Record Prepared? Yes No Filed At DESS. Co. Surveyor's Office Date 3-MAY 1984

History of Surveys, G.L.O., etc. J.H. McCLUNG SET A STONE 18x12x5
SCRIBED A PINE 36" DIA. BEARS N43°30'W 35 LKS DIST

Index File No. 2571 T. 15 S., R. 9 E., W.M. Contract or Surv. No. V-252
 NE Cor. ~~_____~~ 13

Index File No. 2173 CORNER RECORD (SEARCH) Contract or C.S.#3-2
 (Ref. FSM 7151.4) Survey No. -02829 Cor. No. X-21
 T 15 S. R. 9 E. R.D. SISTERS County DESCHUTES 1/4 Cor. of
 Merid. Willamette N.F. Deschutes State Oregon Section 35/36

CORNER DIAGRAM per legend

DESCRIBE CORNER MONUMENT FOUND

SF/NF

DESCRIBE BEARING TREES OR OTHER OFFICIAL ACCESSORIES FOUND

SF/NF

PHOTO IDENTIFICATION DATA

Photo No. _____
 Filed At. _____
 Object Ident. _____
 Ident. By _____

SEARCHED 200' RADIUS AROUND APPROX. PROPORTION LOCATION.

DESCRIBE CORNER LOCATION RELATIVE TO NEAR-BY FEATURES, ALSO HOW TO REACH CORNER

Signature

CORNER LEGEND:

- FS or Unverified
- Contr. Other
- ◊ Searched For/Not Found
- ⊗ ⊗ Evidence Found/Accept.:
- ◆ Permanent Mon. Set/Fd.

Searched By: RCC

Title PLS Division PVT Headquarters

Date 5/84

CORNER RECORD (PERPETUATION)

MONUMENT: DESCRIBE NEW MONUMENT SET, OR WORK DONE TO PRESERVE EXISTING MONUMENT

SET STAKE & 4' LATH MARKED
"APPROX. 1/4 CORNER LOCATION"

MONUMENT STAMPED

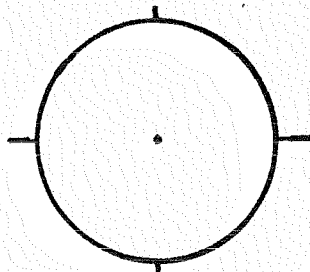

ACCESSORIES: DESCRIBE NEW BT'S WITNESS OBJECTS ETC. ESTABLISHED, OR WORK DONE TO PRESERVE EXISTING EVIDENCE

Work Done By RCC Title PLS Date 5/84 State Registration No. OR-1632

Plat or Certified Cor Record Prepared? Yes No Filed At _____ Co. Surveyor's Office Date _____

History of Surveys, G.L.O., etc. 1870: G.L.O.: SET 14x14x9" STONE ~ NO BT'S MADE.

Index File No 2173 T. 15 S., R. 9 E., W.M. Contract or Surv. No _____ Cor. X-21

Index
File No. 2573

CORNER RECORD (SEARCH)
(Ref. FSM 7151.4)

Contract or
Survey No. 53-0464-3-02829

Cor. No. X-25

T 15 S. R. 9 E. R.D. SISTERS County DESCHUTES E1/4 Cor. of
Merid. Willamette N.F. Deschutes State Oregon Section 36

CORNER DIAGRAM per legend



DESCRIBE CORNER MONUMENT FOUND

ORIGINAL 12X10X5 BASALT STONE
SET FIRMLY IN GROUND, ± 1' WEST of FENCE.

DESCRIBE BEARING TREES OR OTHER OFFICIAL ACCESSORIES FOUND

NONE

PHOTO IDENTIFICATION DATA

Photo No. _____
Filed At. _____
Object Ident. _____
Ident. By _____

DESCRIBE CORNER LOCATION RELATIVE TO NEAR-BY FEATURES, ALSO HOW TO REACH CORNER

FROM INTERSECTION OF RDS. 1567A, 1567E,
1567G TAKE RD. 1567G FOR 1/4 MILE ± TO EDGE
OF CLEAR ON EAST SIDE RD. CORNER LIES IN
NORTH SOUTH FENCE

CORNER LEGEND:

- FS or Unverified
- Contr. Other
- Searched For/Not Found
- Evidence Found/Accept.
- Permanent Mon. Set/Fd.

Searched By: RCC

Title PLS 1632

Division

Headquarters

Date

3-84

CORNER RECORD (PERPETUATION)

MONUMENT: DESCRIBE NEW MONUMENT SET, OR WORK DONE TO PRESERVE EXISTING MONUMENT

SET STANDARD USFS 2 1/2" X 30" GALV. PIPE WITH
A 2 1/2" BRASS CAP FIRMLY IN GROUND WITH A 5"
RISE ABOVE NATURAL GROUND; ERECTED STONE
MOUND AROUND MONUMENT.

MONUMENT STAMPED

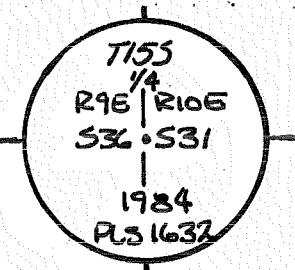

ACCESSORIES: DESCRIBE NEW BT'S WITNESS OBJECTS ETC. ESTABLISHED, OR WORK DONE TO PRESERVE EXISTING EVIDENCE

5" DBH P. PINE BEARS N 70° E 29.61 FT. SCRIBED 1/4 S31 TISS R106 BT
60d NAIL IN NNW BASE

8" DBH P. PINE BEARS S 27 3/4° E 54.56 FT. SCRIBED 1/4 S31 TISS R106 BT
60d NAIL IN ENE BASE

NO AVAILABLE TREE TO THE WEST, IN CLEAR CUT AREA.

Work Done By: RCC Title: PLS 1632 Date: 3-84 State Registration No. OR-1632
or Agency

Plat of PE Cor. Record Prepared? Yes No Filed At: DESEN Co. Surveyor's Office Date 3 MAY 1984

History of Surveys, G.L.O., etc. S JH MCCLUNG SET A STONE 12X10X5

Index File No. 2573

T. 15 S., R. 9 E., W.M.

Contract or Surv. No.

X-25
E 1/4 Cor. 33

Index File No. 1375 CORNER RECORD (SEARCH) (Ref. FSM 7151.4) Contract or Survey N^o. Jefferson Cor. No. Z-13
 T 15 S. R. 9 E. R.D. Sisters County Jefferson Std. Cor. of
 Merid. Willamette N.F. Deschutes State Oregon Section 33 34

CORNER DIAGRAM per legend

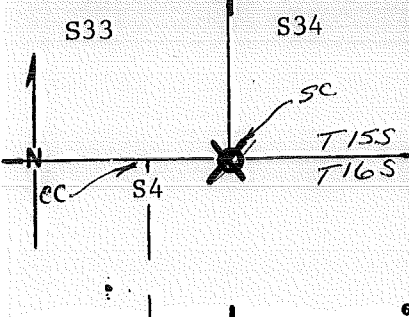

DESCRIBE CORNER MONUMENT FOUND

DESCRIBE BEARING TREES OR OTHER OFFICIAL ACCESSORIES FOUND

8" down log looks like N.E. tree

marks visible: R. S3

PHOTO IDENTIFICATION DATA

Photo No. _____
 Filed At. _____
 Object Ident. _____
 Ident. By _____
Signature

Area has lots of blow downs!!

CORNER LEGEND:

- FS or Contr. Other
- Searched For/Not Found
 - Evidence Found/Accept.
 - Permanent Mon. Set/Fd.

DESCRIBE CORNER LOCATION RELATIVE TO NEAR-BY FEATURES, ALSO HOW TO REACH CORNER

Rd 1536 to Jct. of 1535 follow 1536 for $0\frac{3}{4}$ Mi. take left for $0\frac{2}{10}$ take left for $0\frac{3}{11}$ to sign board on 20" pine (742' east to corner) on left side of road.

Searched By: S.C. Title S.T. Division Headquarters \$0 Date 5-31-83
P.K. S.T.

CORNER RECORD (PERPETUATION)

MONUMENT: DESCRIBE NEW MONUMENT SET, OR WORK DONE TO PRESERVE EXISTING MONUMENT

MONUMENT STAMPED

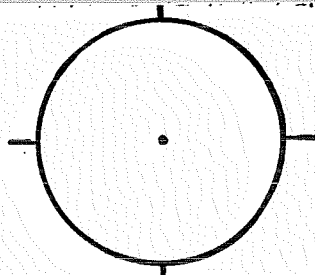

ACCESSORIES : DESCRIBE NEW BT'S WITNESS OBJECTS ETC. ESTABLISHED, OR WORK DONE TO PRESERVE EXISTING EVIDENCE

Work Done By _____ Title _____ Date _____ State Registration No. _____
or Agency _____

Plat or Cor. Record Prepared? Yes No Filed At: Co. Surveyor's Office Date _____

History of Surveys, G.L.O., etc.	1870: 5" spruce pine	7" ^{Spruce Pine} (?Hemlock?)	Stone 14 x 12 x 7 in edge of swamp
	(?Hemlock?)	N15E 73L	Beil - 1952: <u>FD.13"LP&7"</u> Larch both dead.
	N13W 31L	(48 ²)	Also metal poster on 11" spruce from which the corner brs, N24 ⁰ E 10 ⁰² Ft.
	(20 ⁵)		

Index File No. 1375 T. 15 S., R. 9 E., W.M. Contract or Surv. No. _____ Cor. Z-13 _____

Index File No. 1775 CORNER RECORD (SEARCH) Contract or Survey No. Cor. No. Z-17
 (Ref. FSM 7151.4)
 T 15 S. R. 9 E. R.D. Sisters County Jefferson Std. Cor. of
 Merid. Willamette N.F. Deschutes State Oregon Section 34/35

CORNER DIAGRAM per legend

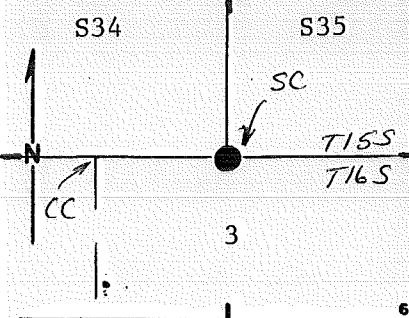

DESCRIBE CORNER MONUMENT FOUND

 Fragmented stones in location

DESCRIBE BEARING TREES OR OTHER OFFICIAL ACCESSORIES FOUND
 34" p pine snag bears ~~N86°W~~ @ 35 FT. ~~TIRRES~~ -- Burned
 N85½°W
 24" P pine snag bears ~~W10°E~~ @ 30 ¼ FT. burned bad (BT)
 N 8 ½ ° E

PHOTO IDENTIFICATION DATA

Photo No. _____
 Filed At. _____
 Object Ident. _____
 Ident. By _____
 Signature _____

75' south of creek

DESCRIBE CORNER LOCATION RELATIVE TO NEAR-BY FEATURES, ALSO HOW TO REACH CORNER
 Paced & compass west from 35
 3 | 2

CORNER LEGEND:

- FS or Unverified
- Contr. Other
- ◊ Searched For/Not Found
- ⊗ ⊗ Evidence Found/Accept.
- ◆ Permanent Mon. Est./Fd.

Sign board put on fire Rd. 600' south of corner

Searched By: S.C. Title S.T. Division Headquarters SQ Date 5-31-83
 D.K. S.T.

CORNER RECORD (PERPETUATION)

MONUMENT: DESCRIBE NEW MONUMENT SET, OR WORK DONE TO PRESERVE EXISTING MONUMENT

1 1/2 x 30" BCSP RSG5" in Md/Stn.

MONUMENT STAMPED

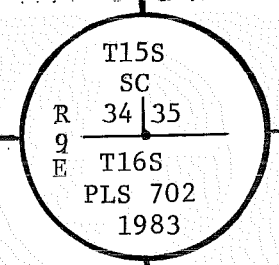

ACCESSORIES: DESCRIBE NEW BT'S WITNESS OBJECTS ETC. ESTABLISHED, OR WORK DONE TO PRESERVE EXISTING EVIDENCE

8" LP Mkd. T15S R9E S35 BT BRS N52° E26⁵⁷ Ft. to 60d nail in NW Base

7" PP Mkd. T15S R9E S34 BT BRS N47^{1/4}° W2⁷⁷ Ft. to 60d nail in ENE Base

Work Done By. R. OMAN Title PLS Date _____ State Registration No. or Agency OR-702

Plat. or Cor. Record Prepared? Yes No Filed At. DESCH. Co. Surveyor's Office Date 23 June 83

History of Surveys, G.L.O., etc.	1870: 48" P	30" P	Stone 24 x 20 x 7
	N86 ^{1/2} W53L	N9°E 46L (30 ⁴)	
	(35°)		

34⁸¹ CH.

Index File No. 1775 T. 15 S., R. 9 E., W.M. Contract or Surv. No. Cor. Z-17

SDA-FOREST SERVICE

File No. 1975

153 R. 9E

Merid. WM

CORNER RECORD (SEARCH)

(Ref. FSM 7151.4)

Tract or Survey No. S3-0466-3-0282

R.D. SISTERS

County DESCHOTES

(S.C.)

N.F. DESCHOTES

State OREGON

CORNER DIAGRAM

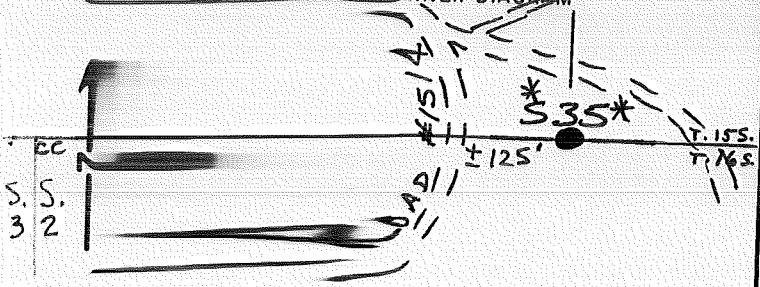

DESCRIBE CORNER MONUMENT FOUND

NONE

DESCRIBE BEARING TREES OR OTHER OFFICIAL ACCESSORIES FOUND

NONE

PHOTO IDENTIFICATION DATA

Photo No. _____

Developed At _____

Project Ident. _____

Identified By _____

Signature _____

PLANE COORDINATE POSITION DATA

Station _____ to _____ Zone _____

Established By _____

Agency _____

Signature RCC

DESCRIBE CORNER LOCATION RELATIVE TO NEAR-BY FEATURES, ALSO HOW TO

CORNER LIES ¹²⁵ ~~100~~ ± EAST OF RD. # 151A
AFTER CROSSING POLE CREEK @ A THREE
INTERSECTION WITH TWO DIRT RDS.

Title PLS 1632 Division _____

Headquarters _____

Date 5/30/84

CORNER RECORD (PERPETUATION)

MONUMENT: DESCRIBE NEW MONUMENT SET, OR WORK DONE TO PRESERVE EXISTING MONUMENT
SET STANDARD USFS 2 1/2" X 30" GALV. PIPE & BRASS CAP
FIRMLY IN GROUND RISING 3" ABOVE NATURAL
GROUND ERECTED STONE ~~MARKED~~ ^{BY THE} AROUND MON.
MARKED AS SHOWN

~~SC~~
T153 R9E
~~SE~~
1/4 335
~~1984~~
PLS 1632

ACCESSORIES DESCRIBE NEW BT'S WITNESS OBJECTS ETC. ESTABLISHED, OR WORK DONE TO PRESERVE EXISTING EVIDENCE

60d NAIL IN W. BASE
A 9" DBH DOUG. FIR BEARS N08°W 28.86 FT. SCRIBED SC 1/4 335 BT
A 6" DBH DOUG. FIR BEARS N58°15'E 63.91 FT SCRIBED SC 1/4 335 BT
60d NAIL IN SE BASE

Work Done By RCC Title PLS 1632 Date 5/84 State Registration No. OR-1632
or Agency
Certified Cor. Record Prepared Yes No Filed At DES. CO. SURV. OFFICE Date 3 MAY 1984

REMARKS

J.H. McCune in 1870 set a 12x10x5 basalt stone
no BT's

Index File No. 1975 T. 153 R. 9E M. LJM Tract or Surv. No. 53-0466-3-02829 Cor. E-29

USDA-FOREST SERVICE

Index

File No. 1975

CORNER RECORD (SEARCH)

(Ref. FSM 7151.4)

Tract or Survey No. S3-0464-3-02829

Cor. No. 51/4

2-19

T 153 R. 9E

R.D. SISTERS County DESCHUTES (S.C.) OF

Merid. WM

N.F. DESCHUTES State OREGON

SEC 35

CORNER DIAGRAM

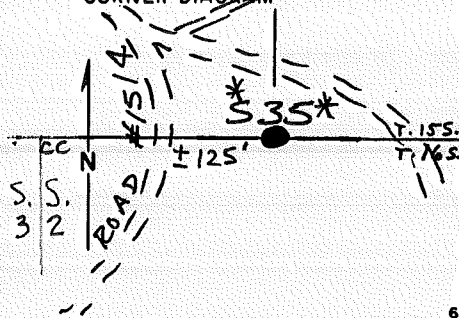

DESCRIBE CORNER MONUMENT FOUND

NONE

DESCRIBE BEARING TREES OR OTHER OFFICIAL ACCESSORIES FOUND

NONE

PHOTO IDENTIFICATION DATA

Photo No. _____

Filed At. _____

Object Ident. _____

Ident. By _____

Signature

PLANE COORDINATE POSITION DATA

State _____ Zone _____

X _____

Y _____

Estob. By _____

Agency

DESCRIBE CORNER LOCATION RELATIVE TO NEAR-BY FEATURES, ALSO HOW TO REACH CORNER

CORNER LIES ¹²⁵ ± EAST OF RD. # 1514
AFTER CROSSING POLE CREEK & A THREE WAY
INTERSECTION WITH TWO DIRT RDS.

Signature

RCC

Title

PLS 1632

Division

Headquarters

Date

5/30/84

7100-52 (3.68)

CORNER RECORD (PERPETUATION)

MONUMENT: DESCRIBE NEW MONUMENT SET, OR WORK DONE TO PRESERVE EXISTING MONUMENT

SET STANDARD USFS 2 1/2" X 30" G.N.V. PIPE & BRASS CAP
FIRMLY IN GROUND RISING 3" ABOVE NATURAL
GROUND ERECTED STONE ~~MARKED~~ ^{BT'S} MOUND AROUND MON.
MARKED AS SHOWN

T155 ^{SC} R9E
~~SE~~
1/4 535
1984
PLS 1632

ACCESSORIES: DESCRIBE NEW BT'S WITNESS OBJECTS ETC. ESTABLISHED, OR WORK DONE TO PRESERVE EXISTING EVIDENCE

60d NAIL IN W. BASE

A 9" DBH DOUG. FIR BEARS N 08° W 28.86 FT. SCRIBED SC 1/4 535 BT

A 6" DBH DOUG. FIR BEARS N 58° 15' E 63.91 FT SCRIBED SC 1/4 535 BT
60 d NAIL IN SE BASE

Work Done By RCC Title PLS 1632 Date 5/84 State Registration No. OR-1632
or Agency
Certified Cor. Record Prepared Yes No Filed At DES-CO. SURV. OFFICE Date 3 MAY 1984

REMARKS

J.H. McCLUNG IN 1870 SET A 12X10X5 BASALT STONE
NO BT'S

53-0466-3-02829

Index File No.
1975

T. 155 R. 9E M. WJM

Tract or Surv. No.

Cor. Z-19

CORNER RECORD (SEARCH)

53-044-3-02829

Index
File No. 2175

(Ref. FSM 7151.4)

Tract or Survey No. _____
Cor. No. Z-21

T. 15 S R. 19 E

R.D. SISTERS County DESCHUTES SW COR OF

Merid. WM

N.F. DESCHUTES State OREGON SEC 36 (S.C.)

CORNER DIAGRAM

DESCRIBE CORNER MONUMENT FOUND

ORIGINAL 15'X10'X4' BASALT STONE IN RING OF STONE

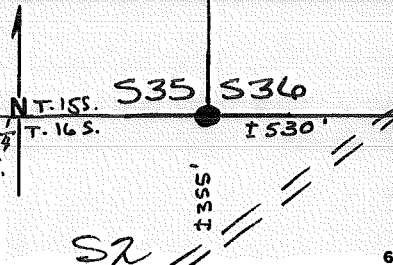

DESCRIBE BEARING TREES OR OTHER OFFICIAL ACCESSORIES FOUND

FOUND STUMP OF ORIGINAL BT THE BT WAS ORIGINALLY SCRIBED AS A 6" NOW A 28" STUMP FOUND VISIBLE SCRIBES "BT"

PHOTO IDENTIFICATION DATA

Photo No. _____
Filed At. _____
Object Ident. _____
Ident. By _____
Signature

DESCRIBE CORNER LOCATION RELATIVE TO NEAR-BY FEATURES, ALSO HOW TO REACH CORNER

CORNER LIES NORTH OF DIRT RD. APPROX 300' OUT IN A CLEAR CUT. FROM GRAVEL RD. # 1514 TURN EAST ON DIRT RD. FOR 1 MILE ±

PLANE COORDINATE POSITION DATA

State _____ Zone _____
X _____
Y _____
Estab. By _____
Agency

Signature RCC

Title PLS 1632 Division +

Headquarters _____

Date 3/30/84

T
CORNER RECORD (PERPETUATION)

MONUMENT: DESCRIBE NEW MONUMENT SET, OR WORK DONE TO PRESERVE EXISTING MONUMENT

SET STANDARD USFS 2 1/2" X 30" GALV. PIPE & BRASS CAP
 FIRMLY IN GROUND RISING 7" ABOVE NATURAL GROUND
 ERECTED STONE ^{MONUMENT} ~~PIPE~~ AROUND MONUMENT.
 MARKED AS SHOWN

TISS R9E
 52
 535 | 536
 TIGS R9E
 52
 1984
 PLS 1632 9

ACCESSORIES: DESCRIBE NEW BT'S WITNESS OBJECTS ETC. ESTABLISHED, OR WORK DONE TO PRESERVE EXISTING EVIDENCE

A 6" ^{WHITE} ~~DOUG.~~ FIR BEARS N 7 3/4° E 186.00 FT. SCRIBED "SC TISS R9E 536 BT"
 60c NAIL IN W. BASE

BEARING OBJECT:

A 6" WHITE FIR BEARS S 34° W 149.00 FT DOUBLE BLAZE SCRIBED "X" IN
 UPPER BLAZE SCRIBED "BO" IN LOWER BLAZE; 60c NAIL IN SE BASE.

10

Work Done By RCC Title PLS Date _____ State Registration No. 1632
 or Agency _____

Certified Cor. Record Prepared Yes No Filed At: DES. CO. SURV. OFFICE Date 3 MAY 1984 11

REMARKS

J.H. McCLUNG SET A STONE 15X10X4 & SCRIBED 6" PINE BEARS N 12° 30' W
 131 LKS

12

Index File No. 2175 T. 155 R. 9E M. WM

Tract or Surv. No. _____

53-0466-3-02229

Cor. 2-21 15
 U.S. G.P.O. 1977-725-576/586

USDA-FOREST SERVICE

Index File No. 2375

CORNER RECORD (SEARCH)
(Ref. FSM 7151.4)

53-0464-3-02829
Tract or Survey No. 2-23
Cor. No. 3/4

T 155 R 9E

R.D. SISTERS County DESCHUTES (S.C.) OF SEC. 36

Merid. WM

N.F. DESCHUTES State OREGON

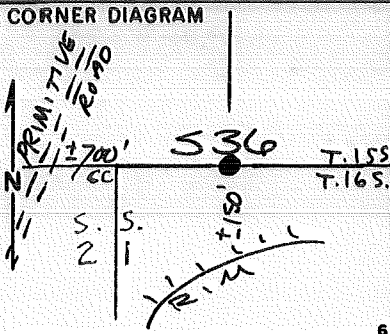

DESCRIBE CORNER MONUMENT FOUND
NONE

DESCRIBE BEARING TREES OR OTHER OFFICIAL ACCESSORIES FOUND
NONE

PHOTO IDENTIFICATION DATA

Photo No. _____

Filed At. _____

Object Ident. _____

Ident. By _____

Signature _____

DESCRIBE CORNER LOCATION RELATIVE TO NEAR-BY FEATURES, ALSO HOW TO REACH CORNER

FROM THE TOP OF SQUAW CREEK RIDGE TAKE SECOND DIRT RD. TO THE WEST FOLLOW DIRT RD. TO THE END TO A LOCATION TAG ON A 4" P. PINE CORNER IS NORTH OF TAG ABOUT 700' CORNER LIES OVER THE CREST OF THE RIDGE ON A STEEP FACE.

PLANE COORDINATE POSITION DATA

State _____ Zone _____

X _____

Y _____

Estab. By _____ Agency _____

Signature RCC Title PLS 1632 Division + Headquarters _____ Date 5/31/84 7100-52-(3/68)

+

CORNER RECORD (PERPETUATION)

MONUMENT: DESCRIBE NEW MONUMENT SET, OR WORK DONE TO PRESERVE EXISTING MONUMENT

SET A STANDARD USFS 2 1/2" X 30" GALV. PIPE & BRASS CAP
 FIRMLY IN GROUND RISING 7" ABOVE NATURAL GROUND
 ERECTED STONE ^{MOUND} ~~PIPS~~ AROUND AROUND MONUMENT

SC
 7155 R 9E
 1/4 S36
 1984
 PLS 1632

ACCESSORIES: DESCRIBE NEW BT'S WITNESS OBJECTS ETC. ESTABLISHED, OR WORK DONE TO PRESERVE EXISTING EVIDENCE

A 10" DBH P. PINE BEARS N63°W 33.41 FT. SCRIBED "SC 1/4 S36 BT"
 60d NAIL IN SW BASE

A 22" DBH P. PINE BEARS N18°30'E 28.41 FT. SCRIBED "SC 1/4 S36 BT"
 60d NAIL IN W. BASE

10

Work Done By: RCC Title: PLS 1632 Date: 5/84 State Registration No. or Agency: OR-1632
 Certified Cor. Record Prepared No Filed At: DES. CO. SURV. OFFICE Date: 2 JUNE 1984

REMARKS

J.H. McCLONG SET A STONE 14X11X8 IN 1871
 NO BT'S

12

Index File No. 2375 T. 155 R. 9E M. UM

Tract or Surv. No.

53-0466-3-02829

Cor. 2-23 13
 U.S. G.P.O. 1977-725-576/586

Index
File No. 2575

CORNER RECORD (SEARCH)
(Ref. FSM 7151.4)

Contract or Survey No. 53-0449-3-02827
Cor. No. E-25

T. 15 S. R. 9 E. R.D. SISTERS County DESCHUTES SE Cor. of
Merid. Willamette N.F. Deschutes State Oregon Section 36 (S.C.)

CORNER DIAGRAM per legend

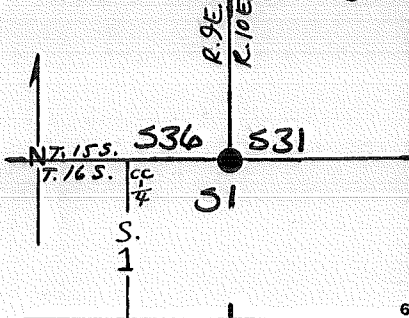

DESCRIBE CORNER MONUMENT FOUND

FOUND ORIG. 24X18X12
CINDER CLINKER STONE FIRMLY SET IN RING
OF STONE. STONE NOW MEASURES 20X18X12

DESCRIBE BEARING TREES OR OTHER OFFICIAL ACCESSORIES FOUND

FOUND ORIG 30" PINE BT DEAD & DOWN. BLAZES
STILL VISIBLE AND FAINT SCRIBES & MARKS. TREE
APPEARS TO BE CLOSE TO ORIGINAL POSITION

PHOTO IDENTIFICATION DATA

Photo No. _____
Filed At. _____
Object Ident. _____
Ident. By _____
Signature _____

RECORD IS 39.6 FT. MEASURE 42' TO CENTERLINE
OF ROOT WAD DEPRESSION

DESCRIBE CORNER LOCATION RELATIVE TO NEAR-BY FEATURES, ALSO HOW TO REACH CORNER

TAKE SECOND ~~BLUFF~~ DIRT RD. TO THE WEST
AFTER PASSING OVER SQUAW CR. CANYON ON
THREE CREEKS RD. FOLLOW DIRT RD. TILL
LOCATION TAG ON NORTH SIDE RD. CORNER LIES
ON CREST OF BLUFF 600' ± ^{NORTH} ~~WEST~~ 100' OF DIRT RD.

CORNER LEGEND:

- FS or Unverified
- Contr. Other
- ◇ Searched For/Not Found
- ⊗ ⊗ Evidence Found/Accept.:
- ◆ Permanent Mon. Set/Fd.

Searched By: RCC

Title PLS 1632

Division _____

Headquarters _____
Date 3-20-84

CORNER RECORD (PERPETUATION)

MONUMENT: DESCRIBE NEW MONUMENT SET, OR WORK DONE TO PRESERVE EXISTING MONUMENT

SET STANDARD USES 2 1/2" X 30" GALV. PIPE WITH
A 2 1/2" BRASS CAP FIRMLY IN GROUND 4"
ABOVE NATURAL GROUND ERRECTED STONE ~~BT~~ ^{MONUMD}
AROUND MONUMENT

MONUMENT STAMPED

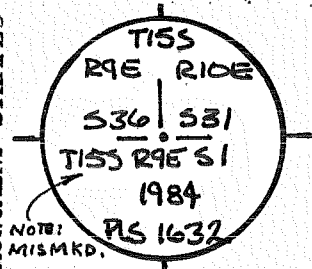

ACCESSORIES: DESCRIBE NEW BT'S WITNESS OBJECTS ETC. ESTABLISHED, OR WORK DONE TO PRESERVE EXISTING EVIDENCE

A 10" DBH P.PINE BEARS N75°W ^{60° NAIL IN SSW BASE} 23.30 FT SCRIBED "TISS R9E 536 BT"
A 4" DBH P.PINE BEARS N69°30'E ^{60° NAIL IN NW BASE} 45.75 SCRIBED DOUBLE BLAZE;
CUT "X" IN UPPER, SCRIBED "BT" IN LOWER BLAZE.

Work Done By RCC Title PLS 1632 Date 3/84 State Registration No. 09-1632
or Agency
Certified PE Cor. Record Prepared? (es) No Filed At DESCH Co. Surveyor's Office Date 3 MAY 1984

History of Surveys, G.L.O., etc. J.H. MCCLUNG SET A STONE 24X18X12 AND SCRIBED A 30" PINE N27°E 60LKS

Index File No. 7575 T. 15 S., R. 9 E., W.M. Contract or Surv. No. 53-0466-3-02829 Cor. 2-25